

**AMKmotion**  
**RACING KIT 2WD**  
**RACING KIT 4WD**  
**"Formula Student Electric"**

Version: 2022/15

Part no.: 205481

Translation of the "Original Dokumentation"

**AMK***motion*

MEMBER OF THE ARBURG FAMILY

## Imprint

**Name:** PDK\_205481\_KW26-S5-FSE-4Q

**Version:**

Version: 2022/15		
Chapter / Topic	Change	Letter symbol
	AMKmotion HTML5	LeS
Various	Changed to 2WD inverter	KoJ

**Previous version:** 2020/44

**Product version:**

Product Part no.	Firmware Version (Part no.)	Hardware Version (Part no.)
AMKmotion RACING KIT 2WD (E1292)	FSER25 SW V1.02 2019/51 (207666)	
AMKmotion RACING KIT 4WD (E1291)		

**Copyright notice:**

© AMKmotion GmbH + Co KG

Any transfer or reproduction of this document, as well as utilisation or communication of its contents, requires express consent. Offenders are liable for the payment of damages. All rights are reserved in the event of the grant of a patent or the registration of a utility model or design.

**Reservation:**

We reserve the right to modify the content of the documentation as well as the delivery options for the product.

**Publisher:**

AMKmotion GmbH + Co KG  
Gaußstraße 37-39  
73230 Kirchheim unter Teck  
Germany

Phone +49 7021 50 05-0  
Fax +49 7021 50 05-176

E-mail: [info@amk-motion.com](mailto:info@amk-motion.com)

Registration court: AG Stuttgart, HRA 230681, Kirchheim unter Teck,  
Tax Id no.: DE 145 912 804

Complementary: AMKmotion Verwaltungsgesellschaft mbH, HRB 774646

**Service:**

Phone +49 7021 50 05-190, Fax -193

For fast and reliable troubleshooting, you can help us by informing our Customer Service about the following:

- Type plate data for each unit
- Software version
- Device configuration and application
- Type of fault/problem and suspected cause
- Diagnostic messages (error messages)

E-mail [service@amk-motion.com](mailto:service@amk-motion.com)

**Internet address:**

[www.amk-motion.com](http://www.amk-motion.com)

## Content

<b>Imprint</b>	<b>2</b>
<b>1 About this documentation</b>	<b>6</b>
1.1 Structure of this document	6
1.2 Keeping this document	6
1.3 Target group	6
1.4 Purpose	7
1.5 Appendant documents	7
1.6 Display conventions	7
<b>2 For your safety</b>	<b>8</b>
2.1 Intended use	8
2.2 Basic notes for your safety	8
2.3 Safety rules for handling electrical systems	8
2.4 Presenting safety messages	8
2.5 Class of hazard	9
2.6 Requirements for the personnel and their qualification	9
2.7 Warranty	9
<b>3 Product overview</b>	<b>10</b>
3.1 Product name and ordering data	10
3.2 Product description	10
3.2.1 Inverter overview	10
3.2.2 Servo motor overview	10
3.2.3 AMK AIPEX PRO software	11
3.2.4 AMK RACING KIT product training	11
3.2.5 Defined level of support	11
3.3 Product view – inverter	11
3.4 Product view – motor	12
3.5 System overview (diagram)	13
3.6 Environmental conditions	13
3.6.1 Transport	13
3.6.2 Operation	14
3.6.3 Storage	14
<b>4 Technical data</b>	<b>16</b>
4.1 Technical data – inverter	16
4.2 Technical data – motor	17
<b>5 Dimensional drawings</b>	<b>18</b>
5.1 Dimensional drawings - Inverter	18
5.1.1 Top view	18
5.1.2 Side view	18
5.2 Dimensional drawings - Motor	19
5.2.1 Side view	19
5.2.2 Front and rear views	19
<b>6 Projecting</b>	<b>20</b>
6.1 Mechanics	20
6.1.1 Mounting options – motor	21
6.1.2 Spline – overview	22
6.1.3 Spline (dimensional drawing)	22
6.2 Cooling circuit	23
6.2.1 Liquid cooling motor	24
6.2.2 Liquid cooling inverter	25
6.2.3 Dew point table	27
6.3 Electric	29

6.3.1 Charging and discharging the HV circuit capacitors	29
6.3.1.1 Calculation example – charging circuit	29
6.3.1.2 Calculation example – discharging circuit	30
6.3.2 PE ground connection – overview	31
6.3.2.1 GND and PE connection – power supply and logic board	33
6.4 Configuration	33
6.4.1 Motor parameters	34
6.4.2 Communication parameters CAN bus	34
6.4.3 FSE parameters	34
6.4.4 Default parameters	36
6.4.4.1 IO Parameter	37
6.4.5 Direction of rotation for motor shaft	37
6.5 Synchronous servo motor with and without field weakening	38
6.5.1 Synchronous servo motor without field weakening	38
6.5.2 Synchronous servo motor with field weakening	38
6.5.3 Characteristics of motor power and motor torque	39
6.5.4 Torque setpoint in field weakening	39
<b>7 Electrical connections</b>	<b>41</b>
7.1 Interface overview and connections – inverter	41
7.1.1 Stranded wires – CAN	43
7.1.2 Stranded wires – HV+ and HV-	44
7.1.3 Stranded wires – motor temperature sensor	44
7.1.4 Stranded wires – motor phases U, V, W	45
7.1.5 [X08] / [X09] 24 VDC supply voltage (on-board supply) and looping	46
7.1.6 [X12] motor thermistor for temperature monitoring	48
7.1.7 [X15] output stage enable (2-channel)	49
7.1.8 [X85] [X86]real-time Ethernet (EtherCAT)	50
7.1.9 [X131] motor encoder	51
7.1.10 [X140] Digital inputs and outputs	53
7.1.11 [X235] USB	54
7.2 Interface overview and connections – motor	55
7.2.1 M12 motor connector (encoder signals and temperature monitoring)	56
7.2.2 Motor cable	57
7.2.3 PE connection	58
<b>8 Functionality</b>	<b>59</b>
8.1 CAN bus (R25)	59
8.1.1 Wiring CAN BUS lines	59
8.1.2 CAN Bus communication	61
8.1.2.1 Mode 'Fixed CAN message configuration'	62
8.1.2.1.1 Parametrization 'Fixed CAN message configuration'	64
8.1.2.2 Mode 'Free CAN message configuration'	66
8.1.2.2.1 Parametrization 'Free CAN message configuration'	72
8.1.2.2.2 Special Signals	75
8.1.2.2.3 SERCOS parameter	77
3586 'System diagnostics: Special software message'	79
3587 'System diagnostics: Special software message'	79
8.2 FSE firmware functional description	80
8.2.1 Controller structure	80
8.2.2 Driving modes	81
3585 'System diagnostics: Special software message'	82
8.2.3 Units	83
8.2.4 Drive behavior in the event of an error	83
8.2.5 Diagram for error scenarios	85
8.2.6 'Remove error' diagram	85

---

8.2.7 Torque limitation	85
8.2.8 Battery protection	87
8.3 Motor encoders	87
<b>9 Startup</b>	<b>88</b>
9.1 Wiring the motor and supply cables	88
9.2 Wiring the interface and control cables	89
9.3 Startup with AIPEX PRO	89
9.4 On and off diagram 'Fixed CAN message configuration'	91
9.5 On and off diagram 'Free CAN message configuration'	93
9.6 Optimizing the current controller	94
9.7 Tuning the speed controller	94
9.7.1 Theoretical basis	95
9.7.2 AIPEX PRO settings	98
9.7.3 Optimising the speed controller	103
<b>10 Service</b>	<b>105</b>
10.1 Error diagnosis with AIPEX PRO	105
10.2 Firmware 'FSER25_SW_102_1951_207666' flash	107
<b>11 Certificates</b>	<b>113</b>
<b>Glossary</b>	<b>114</b>
<b>Your opinion is important!</b>	<b>116</b>

## 1 About this documentation

### 1.1 Structure of this document

Topic	Chapter	Chapter number
Validity, use, and the purpose of the document	Imprint	-
	About this documentation	1
Safety	For your safety	2
Information for planning and configuration personnel	Product overview	3
	Technical data	4
	Dimensional drawings	5
	Project planning <ul style="list-style-type: none"> <li>• Mechanics</li> <li>• Liquid cooling</li> <li>• Electrics</li> <li>• Configuration</li> </ul>	6
Practical information for startup, operating, or maintenance personnel	Electrical connections	7
	Functionality	8
	Startup <ul style="list-style-type: none"> <li>• Wiring the motor and supply cables</li> <li>• Wiring the interface and control cables</li> <li>• Startup with AIPEX PRO</li> <li>• Optimization</li> </ul>	9
	Service	10
Reference to Certificates e. g. CSA, CE or TÜV	Certificates	11
Explanations of abbreviations and terms	Glossary	-

### 1.2 Keeping this document

This document must permanently be available and readable at the place where the product is in use. If the product is used at another place or changed the owner, the document must be passed on.

### 1.3 Target group

Any person that is qualified and intends to work with this product must read, understand and follow this document:

- Transportation and storage
- Unpacking and installation
- Projecting
- Connection
- Parameterization
- Startup
- Testing and maintenance
- Decommissioning and disposal
- Replacement

## 1.4 Purpose

This document is addressed to any person who handles the product. It gives information about the following topics:

- Safety messages which are absolutely necessary to take care of during handling the product
- Product identification
- Projecting, planning and dimensioning of the application
- Environmental conditions for storage, transportation and operation
- Assembly
- Electrical connections
- Startup and operation
- Maintenance
- Replacement
- Diagnosis
- Technical data



## 1.5 Appendant documents

You can get the appendant documentations via the AMK FSE Online Help:

<https://amk-group.com/amk-dokucd/dokucd/FSE/start.htm>



## 1.6 Display conventions

Display	Meaning
	This symbol points to parts of the text to which particular attention should be paid!
	The red hand symbol indicates the button or menu item to click on. The red hand symbol indicates the option to be selected.
 RMB	Click the right mouse button
0x	0x followed by a hexadecimal number, e. g. 0x500A
'Names'	Names are represented with apostrophes e. g. parameters, variables, etc.
'Text'	Menu items and buttons in a software or on a controller, e. g.: Click the <b>'OK'</b> button in the <b>'Options'</b> menu to call up the <b>'Delete PLC program'</b> function
→	Task procedure / operating sequence, e. g. <b>'Start'</b> → <b>'All programs'</b> → <b>'Additional'</b> → <b>'Editor'</b> e. g. 0 → 1 edge
See 'chapter name' on page x	Executable cross-reference in electronic output media
IDxxxx - x	List parameter with element number e. g. ID32798 - 1

## 2 For your safety

### 2.1 Intended use

The AMK RACING KIT is intended for installation in a Formula Student Electric Car and may only be operated within the specified limits (characteristic curve on motor data sheet, motor type plate).

To comply with the requirements of intended use, the motors must be connected to the inverter included in the RACING KIT. Connecting the motors directly to the supply network is prohibited and can lead to material damage!

The RACING KIT may only be operated on a race track that been cordoned off, and is not approved for use on public roads. Before commissioning, the customer must clarify which conditions and requirements must be met in connection with the racing kit application.

Use in the following areas is prohibited:

- Potentially explosive environments
- Environments containing oils, acids, gases, vapors, dusts, radiation, etc.
- Environments that do not meet the climatic conditions specified in this documentation

### 2.2 Basic notes for your safety

- At electrical drive systems, hazards are present in principle that can result in death or fatal injuries:
  - Electrical hazard (e. g. electric shock due to touch on electrical connections)
  - Mechanical hazard (e. g. crush, retract due to the rotation of the motor shaft)
  - Thermal hazard (e. g. burns due to touch on hot surfaces)
- These hazards are present while starting up and operating the unit, and also during servicing or maintenance work.
- Safety instructions in the documentation and on the product warn about the hazards.
- Personnel must have read and understood the safety instructions before installing and operating the product. In the documentation about the product the usage warnings pertain to direct hazards and must therefore be followed directly when operating or handling the product by the operator.
- AMKmotion products must be kept in their original order, that means it is not allowed to do a significant constructional change on hardware side and software is not allowed to be decompiled and change the source code.
- Damaged or faulty products are not allowed to be integrated or put into operation.
- Do not start the system in which the AMKmotion products are installed (begin of intended use) until you can determine that all relevant standards, laws, and directives have been complied with, e. g. low voltage directive, EMC directive, and the machinery directive, and possible further product standards. The plant manufacturer is responsible for the compliance with the laws, directives, and standards.
- The devices must be installed, electrically connected and operated as shown in the device description documentation. The technical data and the required environmental conditions must be observed at all times.

### 2.3 Safety rules for handling electrical systems

In particular on drive systems, the instructions pertaining to safety and the following five safety rules have to be kept in the specified sequence:

1. Switch off electrical circuits (also electronic and auxiliary circuits).
2. Secure against being switched on again.
3. Determine that there is no voltage.
4. Ground and short circuit.
5. Cover or close off neighboring parts that are under voltage.

Reverse the measures taken in reverse order after completing the work.

### 2.4 Presenting safety messages

Any safety information is configured as follows:





 <b>SIGNAL WORD</b>
--



 Symbol	<b>Type and source of risk</b> Consequence(s) of non-observance  <b>Steps to prevent:</b> • ...
---	---

## 2.5 Class of hazard

Safety and warning messages are graduated into classes of hazard (according to ANSI Z535). The class of hazard defines the potential risk of harm and is described by a single word, if the safety information is ignored. The signal word is followed by a safety alert symbol (ISO 3864, DIN EN ISO 7010). In accordance with ANSI Z535, the following signal words are used to define the class of hazard.

Safety alert symbol and signal word	Class of hazard and its meaning
	DANGER indicates a hazardous situation which, if not avoided, <b>will</b> result in death or serious injury
	WARNING indicates a hazardous situation which, if not avoided, <b>could</b> result in death or serious injury
	CAUTION, used with the safety alert symbol, indicates a hazardous situation which, if not avoided, <b>could</b> result in minor or moderate injury
	NOTICE is used to address preventions to avoid material damage, but not related to personal injury.

## 2.6 Requirements for the personnel and their qualification

Only authorized and qualified personnel may work on and with the AMKmotion drive systems.

Specialised personnel must:

- Perform mechanical and electrical work that is described in this documentation, such as mounting and connecting
- Observe all information in the documentation accompanying the product in order to work with the product safely and in an error-free manner
- Understand and know hazards that occur when handling the product
- Know connections and functions of the system
- Be familiar with the control concept in order to operate the drive system
- Be authorized to switch circuits and devices on and off, ground and label them
- Observe local specific safety requirements

## 2.7 Warranty

- All information in the documents accompanying the product must be complied with for a safe and trouble-free operation.
- The assertion of warranty claims is excluded if the information in the documents is not observed completely.
- Hardware and firmware may not be modified except by personnel authorized by AMKmotion and after consultation with AMKmotion.
- The company AMKmotion GmbH + Co KG is not liable for damages from unintended use, incorrect installation or operation, exceeding rated values and non-observance with the environmental conditions.

### 3 Product overview

#### 3.1 Product name and ordering data

Product name	Order number
AMKmotion RACING KIT 2WD	E1292
AMKmotion RACING KIT 4WD	E1291

The AMKmotion RACING KIT consists of the following components:

Product name	Quantity	Order number
DYNASYN synchronous servo motor DD5-14-10-POW-18600-B5	2 or 4	A2370DD
AMKASYN inverter KW26-S5-FSE-2Q	1 or 2	E1293
AMKmotion AIPEX PRO V3 startup software	1	O907
USB cable with ferrite, 3 m	1	47058
AMKmotion RACING KIT product training at AMK in Kirchheim/Teck or online	1	N308
10 hours of phone and/or e-mail support from AMKmotion. E-mail: application@amk-motion.com	1	-

#### 3.2 Product description

The AMKmotion RACING KIT consists of one or two 2WD inverter with integrated drive controllers and two or four synchronous servo motors. For startup, the kit contains the AMKmotion AIPEX PRO V3 software and a USB cable.

The torque at the servo motor is controlled subject to the setpoint (accelerator position). The setpoint for the inverters is specified via a higher-level CAN controller. The inverters can operate the servomotors in torque control (open loop) or speed control (closed loop) mode. Speed control versus torque control, the advantage of speed control is that the motor speed can be limited dynamically in addition to the limitation of the torque.

The inverters are operated with the AMKmotion 'Formula Student Electric' firmware. 'Formula Student Electric' is subsequently abbreviated in the documentation to 'FSE'.

Communication between the inverters and the higher-level controller takes place via a CAN bus 2.0 A (High-Speed CAN). For the CAN message exchange, you can use fixed messages (mode 'Fixed CAN message configuration') or a application-specific configuration (mode 'Free CAN message configuration').

The servo motors can be driven by a motor and a generator (recuperative).

##### 3.2.1 Inverter overview

- Field-based regulation of permanent-magnet synchronous servo motors
- Speed control with torque limitation for motor and recuperative operation
- Temperature monitoring of the motor and inverter
- Torque limitation in the event of overload and excess temperature
- Torque limitation in the event of undervoltage or overvoltage in the HV circuit
- CAN bus 2.0 A (High-Speed CAN)
- I/O interface (motor control and motor torque hardware release, hardware signal 'derating' active)
- EtherCAT (SoE), USB (AMKmotion AIPEX PRO software) service interface
- Mounted on liquid-cooled cold plate

##### 3.2.2 Servo motor overview

- Permanent-magnet synchronous servo motors
- $M_{max}/M_N = 2.1$
- Field-weakening operation possible, speeds up to 20,000 rpm
- Digital EnDat encoder (AMKmotion classification P)
- KTY temperature sensor
- Shielded power cable
- M12 plug for encoder signals and temperature monitoring
- Motor casing made from aluminum 3.4365/EN AW-7075

- Shaft with spline as per DIN 5480
- Rear or front mounting
- The liquid cooling jacket must be designed and constructed by the user

### 3.2.3 AMK AIPEX PRO software

- Configuration
- Startup, optimization (oscilloscope)
- Diagnosis
- Interface to inverter: EtherCAT or USB

### 3.2.4 AMK RACING KIT product training

A 2-day training course for 2 participants at AMK in Kirchheim/Teck, Germany, is included in the price of the package (alternatively online).

Training content:

- Device overview
- Connection technology
- CAN interface
- Working with the AMKmotion AIPEX PRO startup software
- Configuration and startup

Accommodation and travel costs are to be borne by you.

### 3.2.5 Defined level of support

10 hours of phone and/or e-mail support from AMK is included in the price of the package.

Email: [application@amk-group.com](mailto:application@amk-group.com)

## 3.3 Product view – inverter

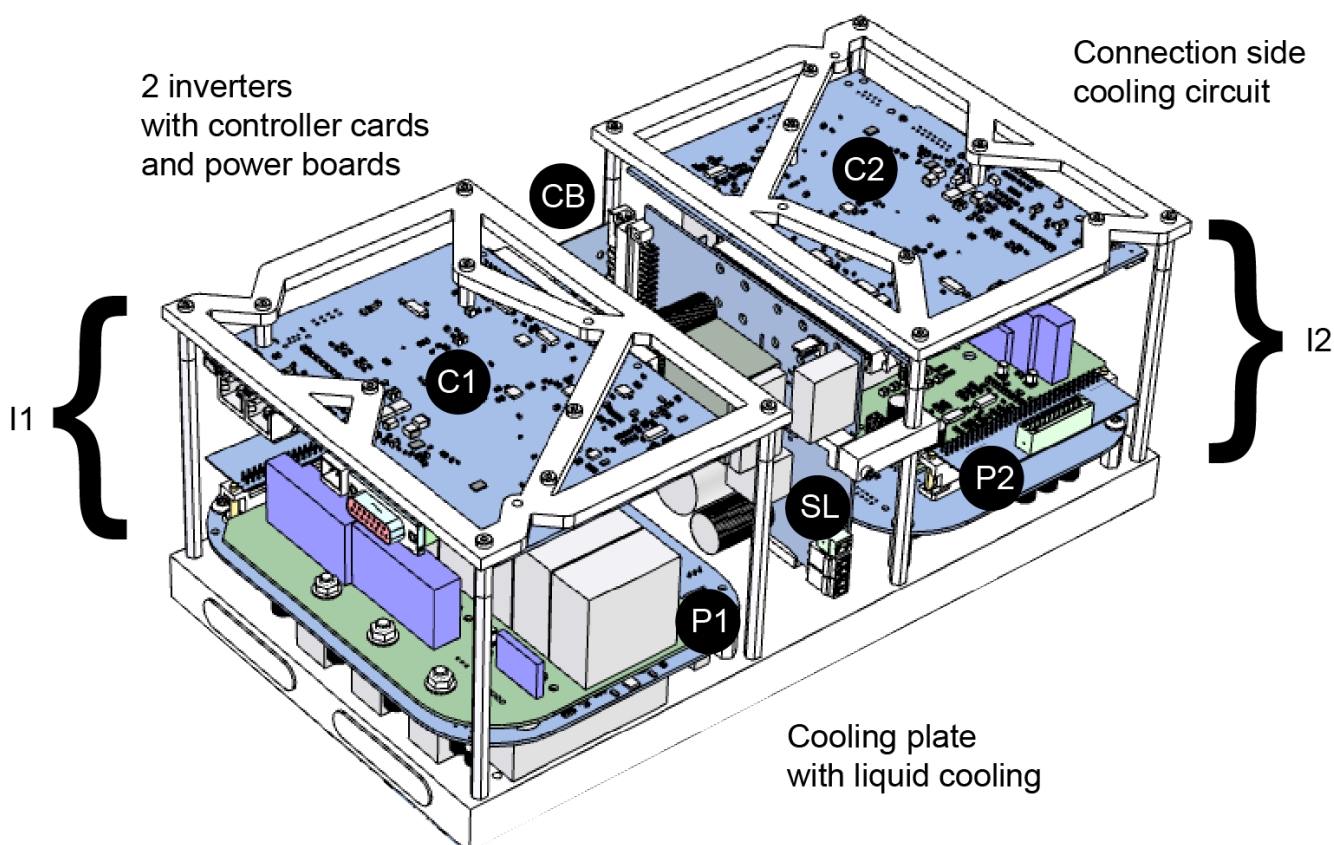

With respect to the illustrations shown in the documentation, please pay attention to the label 'Cooling circuit connection side'.

- I(1/2) - Inverter (contains power electronics and a controller card for a motor)
- P(1/2) - Power electronics for inverter I(1/2)
- C(1/2) - Controller card for inverter I(1/2)
- SL - Power supply and logic board for I1 and I2
- QB - Transverse board, connects I1 with I2

### 3.4 Product view – motor

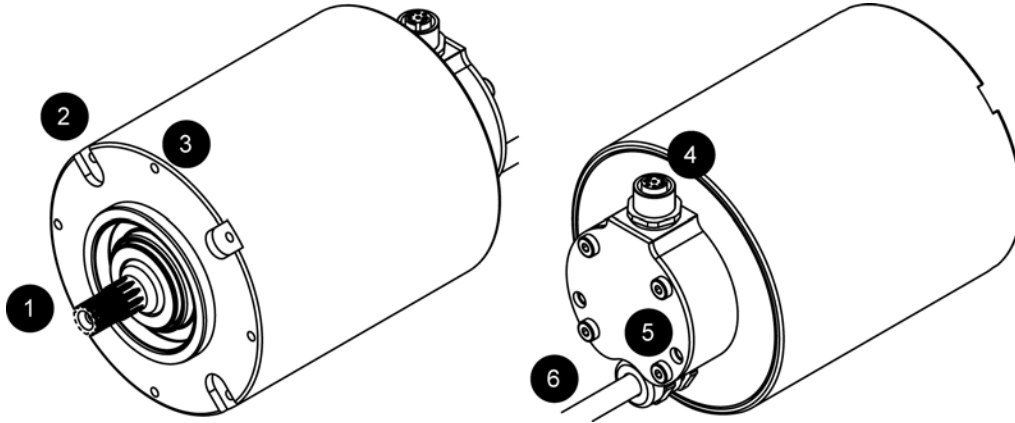

- 1 - Motor shaft with spline
- 2 - Notch for mounting plate
- 3 - Mounting thread
- 4 - Motor connector (encoder signals and temperature sensor)
- 5 - PE connection (2 x)
- 6 Motor cable (phases U, V, W)

### 3.5 System overview (diagram)

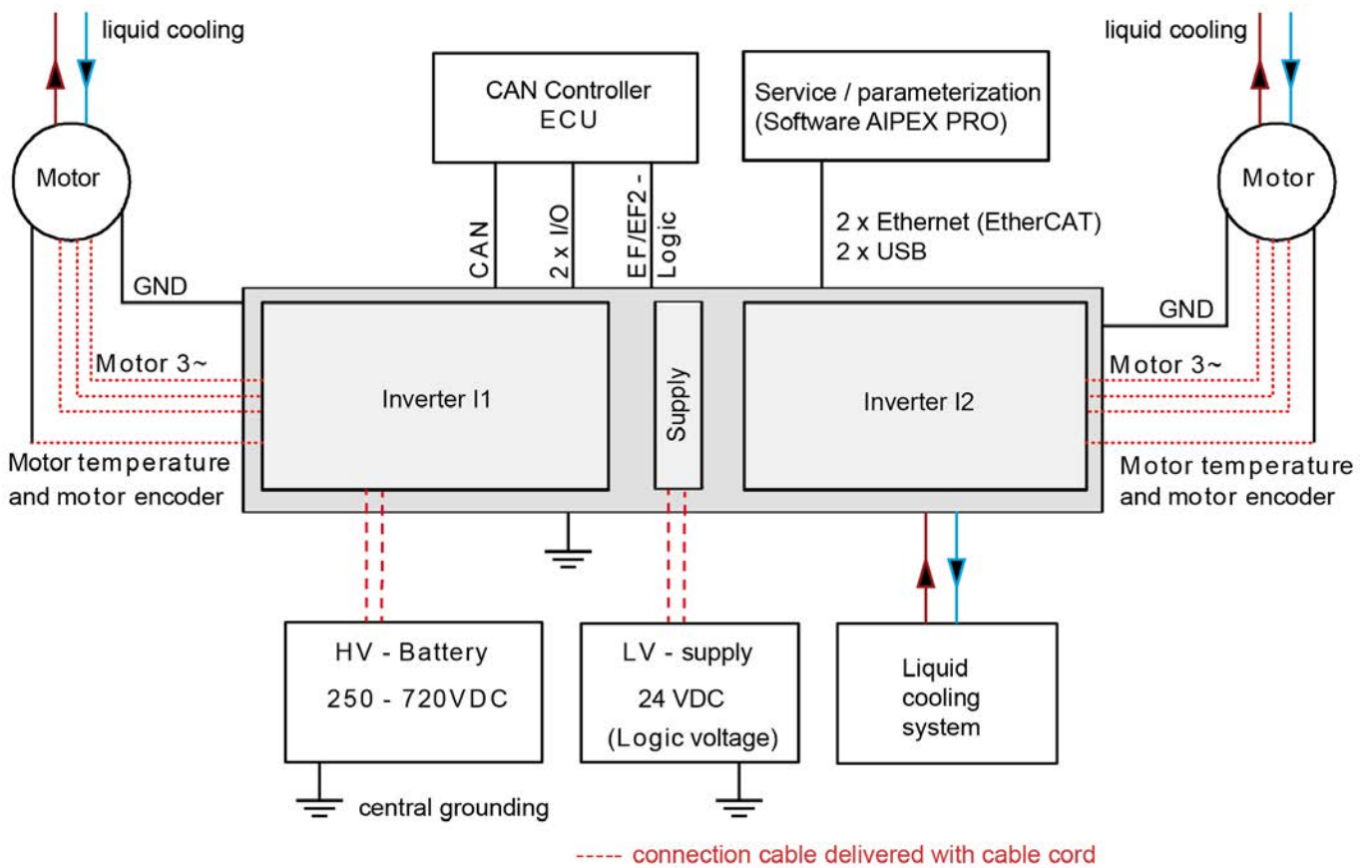

### 3.6 Environmental conditions

#### 3.6.1 Transport

The product may be transported in the AMK original packaging under the following conditions:

##### Transport conditions according to EN 61800-2

Description	Value range
Ambient temperature	-25 °C (-13 °F) to 70 °C (158 °F)
Relative humidity	5 % to 95 %



The products may only be unpacked and installed when the product has adapted to the room temperature, otherwise condensation can form.

Check the delivered goods for damage in transit.

### 3.6.2 Operation

NOTICE	
<b>Material Damage!</b>	<p><b>Material damage due to overheating!</b></p> <p>The motor is intended solely for operation in a closed cooling circuit with a heat exchanger. Operation without the specified liquid cooling system is not permitted. The motor will overheat. The insulation in the motor is impaired or destroyed. Overheated permanent magnets are permanently weakened.</p> <p><b>Preventive measures:</b></p> <ul style="list-style-type: none"> <li>• Only operate the motor with the specified liquid cooling system</li> <li>• Connect the PTC thermistor from the servo motor to the temperature monitoring equipment</li> <li>• Activate the I<sup>2</sup>t monitoring of the servo motor in ID32773 'Service bits', bit 14</li> </ul>

#### FSE Inverter

Description	Value range
Ambient temperature	+5 °C (41 °F) to +40 °C (104 °F)
Relative humidity	5 % to 85 % (no condensation)
Installation height	Up to 1000 m above sea level. If installed at elevations of 1000 m to max. 2000 m above sea level, the nominal data has to be lowered by 1 % per 100 m.
Schock resistance (EN 60068-2-27)	15 g for 11 ms
Vibration resistance (EN 60068-2-6)	1 g (10... 150 Hz)
Pollution degree (EN 61800-5-1)	Pollution degree 1 The interior of the device is designed for no or only dry, non-conductive contamination.

#### FSE Motor

Description	Value range
Ambient temperature	+5 °C bis +40 °C Derating: from 40 °C (104 °F) to 60 °C (140 °F) 1% per 1K
Relative humidity	5 % bis 85 % (no condensation)
Installation height	To 1000 m above sea level
Schock resistance (EN 60068-2-27)	100 g
Vibration resistance (EN 60068-2-6:)	20g (55... 2000 Hz)
Pollution degree (EN 61800-5-1)	Pollution degree 1 The interior of the device is designed for no or only dry, non-conductive contamination.

### 3.6.3 Storage

The product may be stored in the AMKmotion original packaging under the following conditions:

**FSE inverter**

Description	Value range
Storage location	Clean, dry, protected from the weather Protected against sudden changes in temperature and humidity Protected against salt spray, industrial gases and corrosive liquids Protected against mold, mushrooms, rodents, termites and other animal pests
Storage height	2000 m above sea level
Ambient temperature	-25 °C (-13 °F) to +55 °C (-131 °F)
Relative humidity	5 % to 95 %
Highest permissible temperature change	Temperature fluctuations must not occur to the extent that the product surfaces are exposed to the conditions of sweating and freezing.

**Storage period**

Up to one year under conditions in accordance with EN 61800-2

**Note for electrolytic capacitors - reforming**

If the electrolytic capacitors of the converters are not in operation, because the device is in storage or switched off, the residual current behaviour is changed at next restart. The residual current is the leakage current which is very high after switch on dc voltage and decreases to nominal after approximately 5 minutes. The longer time the electrolytic capacitor is voltage-free the higher is the leakage current which can destroy the inverter. After 2 years without voltage supply the inverters must be connected to HV voltage and electronic voltage for 1-2 hours HV voltage ON and Controller enable OFF [RF=0]) to reform the capacitors, means to reduce the leakage current to nominal value. After that, the converters can be stored again.

**FSE motor**

Description	Value range
Storage location	Clean, dry, protected from the weather Protected against sudden changes in temperature and humidity Protected against salt spray, industrial gases and corrosive liquids Protected against mold, mushrooms, rodents, termites and other animal pests
Storage height	2000 m above sea level
Storage position	Store the motors with the shaft in a horizontal position
Vibration	If the motors are stored incorrectly there is risk of bearing damage such as brinelling, for example as a result of vibration.
Ambient temperature	+5 °C (41 °F) to +40 °C (104 °F)
Relative humidity	Relative humidity max. 60 %
Highest permissible temperature change	Temperature fluctuations must not occur to the extent that the product surfaces are exposed to the conditions of sweating and freezing.

**Preparation for storage:**

- The circuits of the liquid cooling have to be emptied and purged with air
- Avoid contact corrosion
- Protect bare external parts with a preservation agent, e.g.: Oil the shaft ends or coat with peel-off paint, if this has not already been done at the factory

**Maintenance intervals:**

In the event of machine downtimes of more than 4 weeks, we recommend starting up the machine once a month or rotating the rotor shaft.

**Storage period**

Storage periods of up to 2 years under storage conditions compliant with EN 61800-2.

No special measures are needed prior to startup.

If motors were in storage for more than 2 years, we recommend a lubrication change. To do this, contact AMK.



Products taken from the storage may only be unpacked and installed when the product has adapted to the room temperature, otherwise condensation can form.

## 4 Technical data

### 4.1 Technical data – inverter

	Terminal / strand	KW26-S5-FSE-4Q (2WD inverter) (data per inverter)	
Rated input voltage HV+, HV- power supply	HV+, HV-	540 VDC	
Input voltage range		250 VDC - 720 VDC	
Input current Power supply for HV = 540 VDC		48 A	
Intermediate circuit capacity		75 $\mu$ F	
Supply voltage for logic supply LV	X08 (X09)	24 VDC $\pm$ 15%, The 0 V potential must be connected to the vehicle ground (vehicle chassis).	
Input current for logic supply LV		$\leq$ 500 mA	
Capacity at input of internal switched-mode power supply		1,500 $\mu$ F	
Efficiency		Approx. 98%	
Ground		Vehicle ground (vehicle chassis) or ground strap Switching GND for logic voltage is internally connected to the frame of the inverter	
Control method Switching frequency		PWM 8 kHz	
Output frequency <sup>1)</sup>	U, V, W	0 - 1200 Hz	
Output voltage (HV = 540 VDC)		350 VAC (sinusoidal output current)	
Output voltage range (HV = 250 - 720 VDC)		160 - 490 VAC	
Rated output power		26 KVA	
Rated output current $I_N$		43 A	
Peak output current $I_{max}$		107 A	
Max. duration of peak output current $I_{max}$ • Output frequency $f_{OUT} > 1$ Hz		10 s	
Max. duration of peak output current $I_{max}$ • Output frequency $f_{OUT} \leq 1$ Hz		1 s	
Temperature sensor evaluation		X12	KTY e.g., KTY84-130
Protective / monitoring function		Short-circuit / ground fault, intermediate circuit overvoltage, excess temperature at motor / heat sink, current overload as per I <sup>2</sup> t	
Galvanic isolation voltage between HV and LV		2200 VDC	
Cooling	Liquid cooling		
Flow rate	1.5 bar / 10 l/min		
Max. cold plate and ambient temperature	40 °C		
Protection class	IP 00		



	Terminal / strand	KW26-S5-FSE-4Q (2WD inverter) (data per inverter)
<b>Dimensions (2WD inverter)</b>	Approx. 339 mm length, approx. 183 mm width, approx. 131 mm height	
<b>Weight for 2WD inverter including heat sink</b>	Approx. 6,3 kg	

1) Speed setpoint values are limited to 30000 rpm

## 4.2 Technical data – motor

Please refer to the motor data sheet (see: Motor\_data\_sheet\_A2370DD\_DD5) for the technical data for the motor.



When the system is started up for the first time, the motor parameters are automatically transferred from the encoder database to the inverter.

The function is not performed if the motor parameters have already been entered manually. The AIPEX PRO's 'Initial program loading' (PW: 500591) function in direct mode allows the factory settings from AMK to be restored.

Prerequisite for the automatic transfer of the data from the encoder database:

- Encoder cable connected
- Motor parameters have not already been changed manually
- The data has been stored in the encoder at the factory

## 5 Dimensional drawings

### 5.1 Dimensional drawings - Inverter

#### 5.1.1 Top view

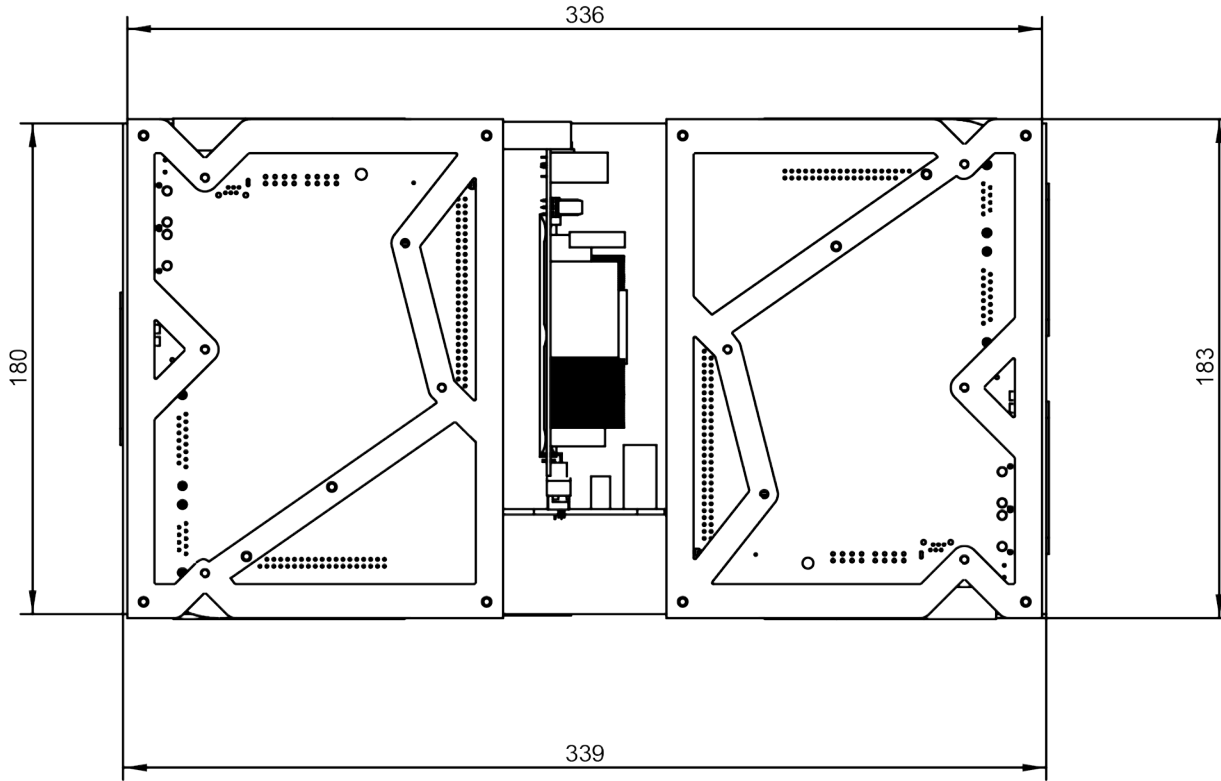

#### 5.1.2 Side view

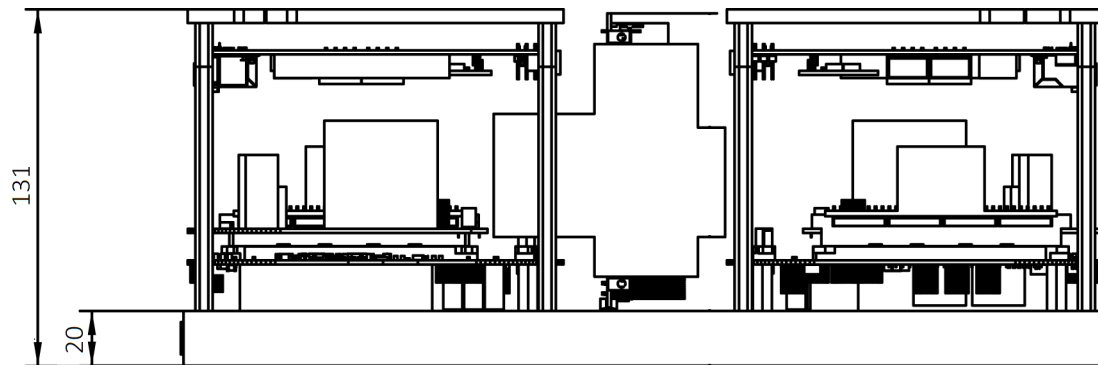

## 5.2 Dimensional drawings - Motor

### 5.2.1 Side view

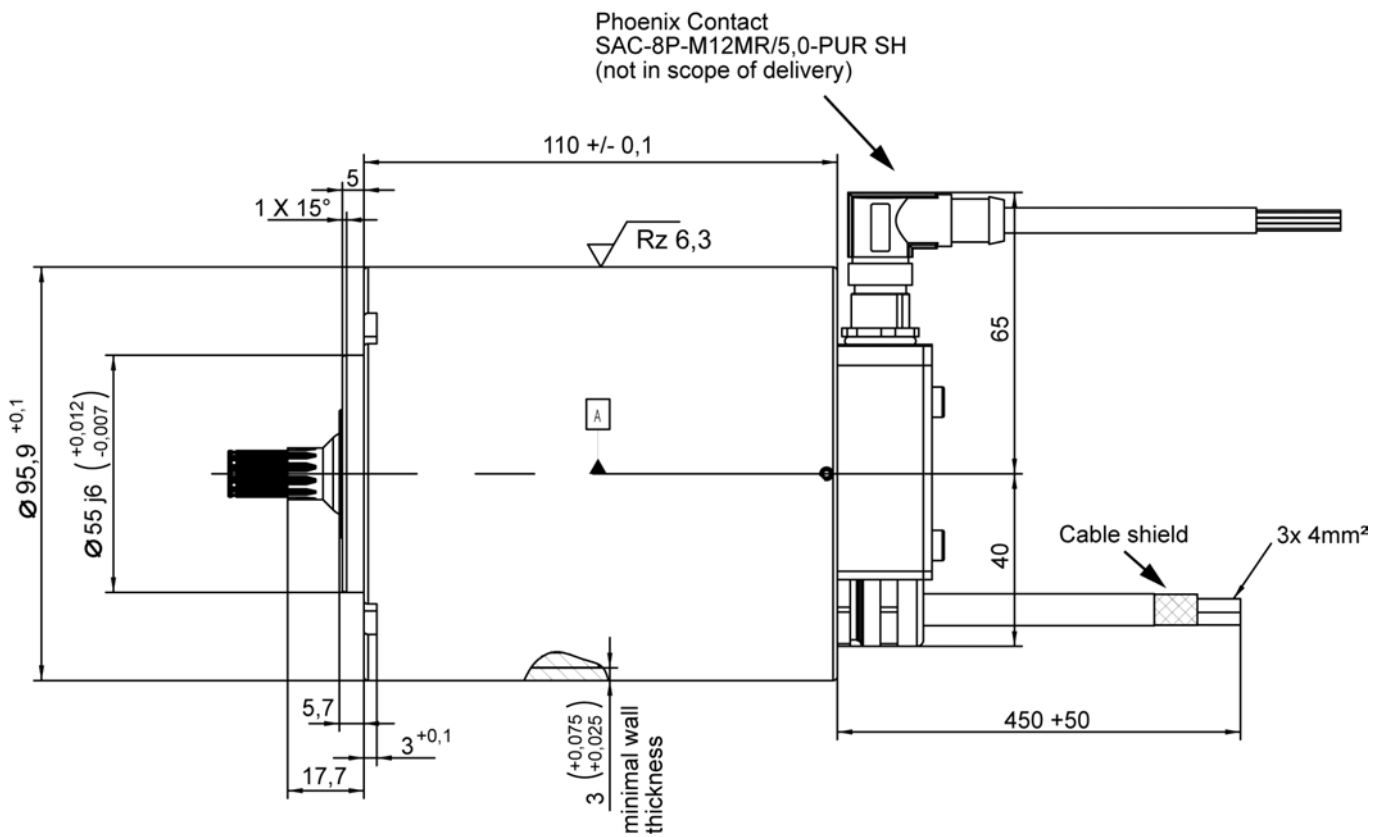

### 5.2.2 Front and rear views

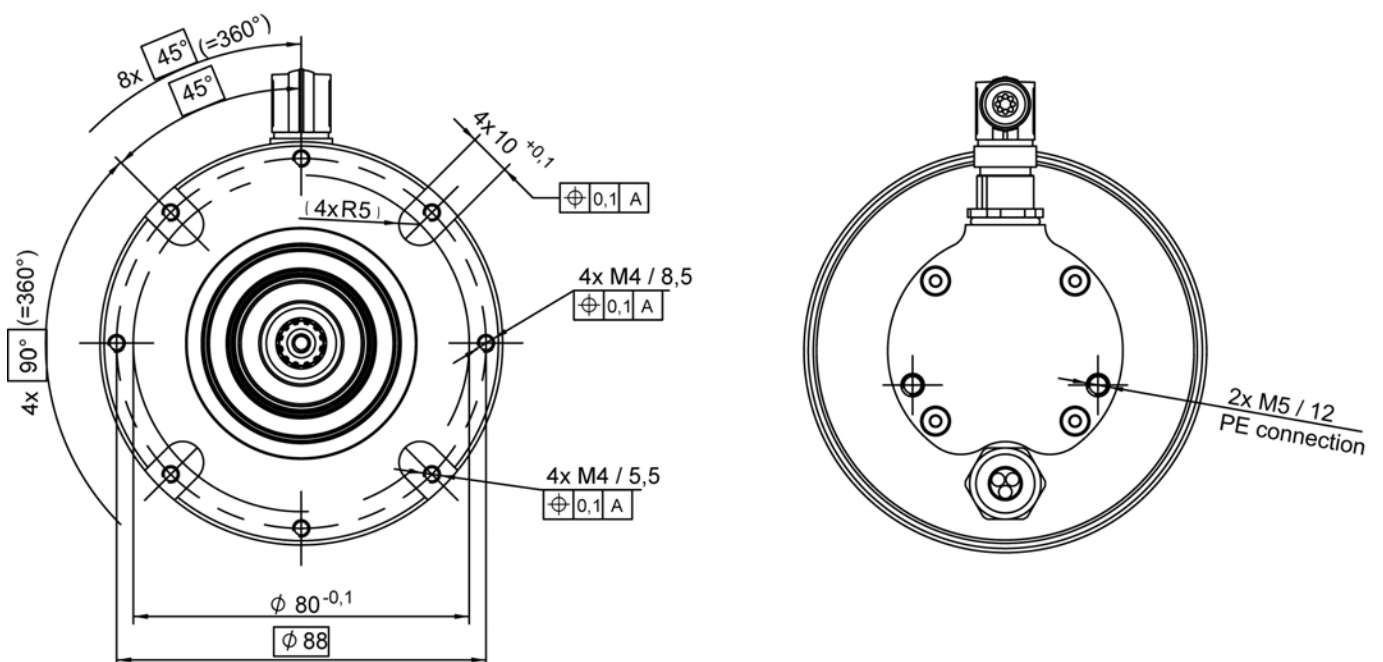

Dimensional drawing of spline: [Siehe 'Spline \(dimensional drawing\)' auf Seite 22.](#)

## 6 Projecting

### 6.1 Mechanics

NOTICE	
<b>Material Damage!</b>	<p><b>Mechanical damage due to pressure on the motor shaft</b></p> <p>Pressure on the motor shaft can damage the motor bearings or cause the motor shaft to move out of its fixing and into the motor casing.</p> <p><b>Preventive measures:</b></p> <p>Mounting parts such as toothed wheels or shafts must be attached without force (not pressed in) and must then be secured with a screw or a retaining ring.</p>

NOTICE	
<b>Material Damage!</b>	<p><b>Mechanical damage due to pressure on the B-bearing shield</b></p> <p>By pressing on the B-bearing shield the housing screws may break. The motor housing is damaged and the B-bearing shield is moving into the motor housing.</p> <p><b>Preventive measures:</b></p> <p>Support mechanically the motor housing (picture pos. 1 + 2) so that during assembly of attachments e. g. the external liquid cooling no pressure on the B-bearing shield is applied.</p> <div style="text-align: right;">  </div>

### 6.1.1 Mounting options – motor

The motor can be mounted either at the rear via the 8 x M4 threads or at the front.

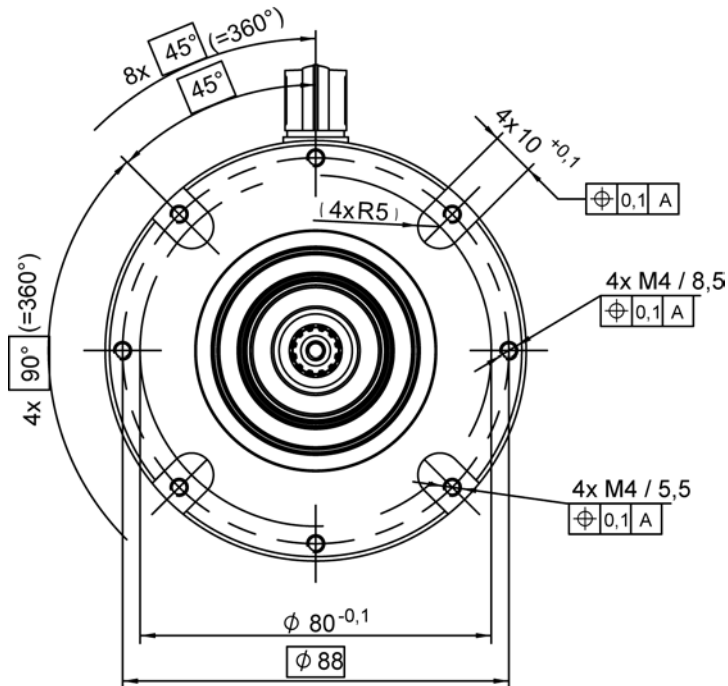

#### Front mounting

The mounting plates indicated in the drawing are required for front mounting. The mounting plates are not included in the scope of delivery and must be provided by the user.

The mounting plates can be fastened in the front end of the motor at the 4 x 10 mm wide notches.

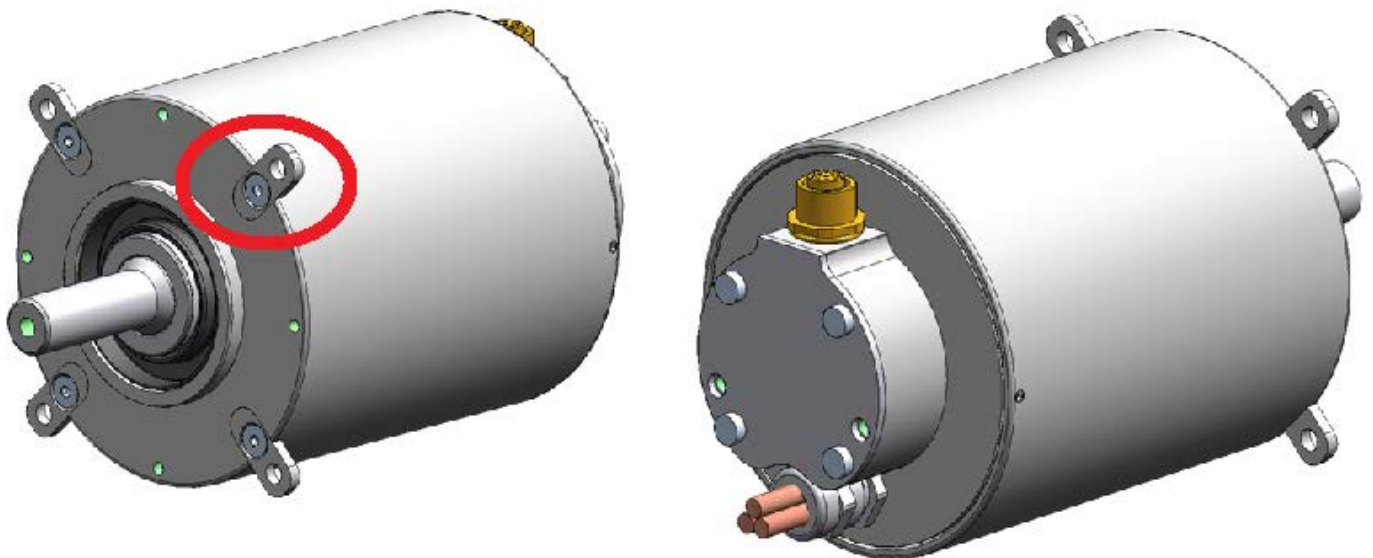

#### Rear mounting

Fixation via 8 x M4 threads.

### 6.1.2 Spline – overview

#### NOTICE

#### Material Damage!

#### Mechanical damage due to pressure on the motor shaft

Pressure on the motor shaft can damage the motor bearings or cause the motor shaft to move out of its fixing and into the motor casing.

#### Preventive measures:

Mounting parts such as toothed wheels or shafts must be attached without force (not pressed in) and must then be secured with a screw or a retaining ring.

The motor shaft contains a spline in accordance with DIN 5480 – W11 x 0.8 x 30° x 12 x 7h

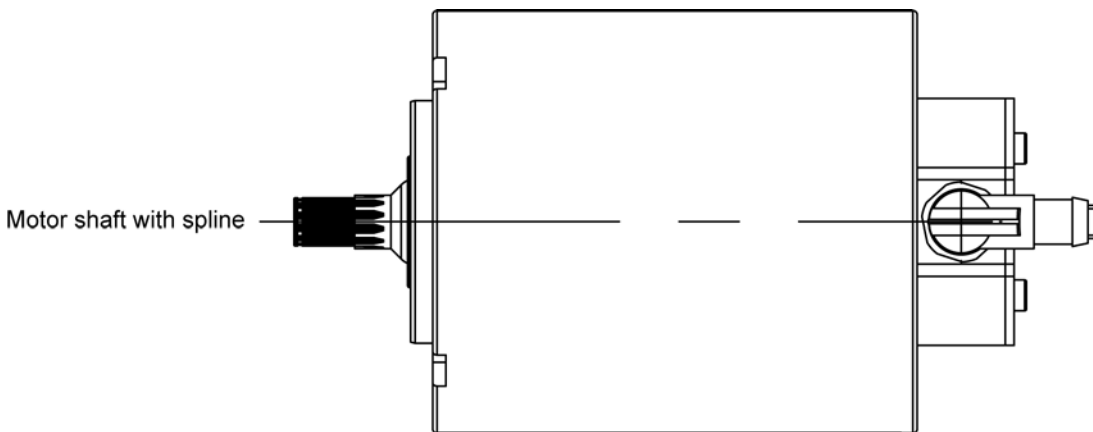

### 6.1.3 Spline (dimensional drawing)

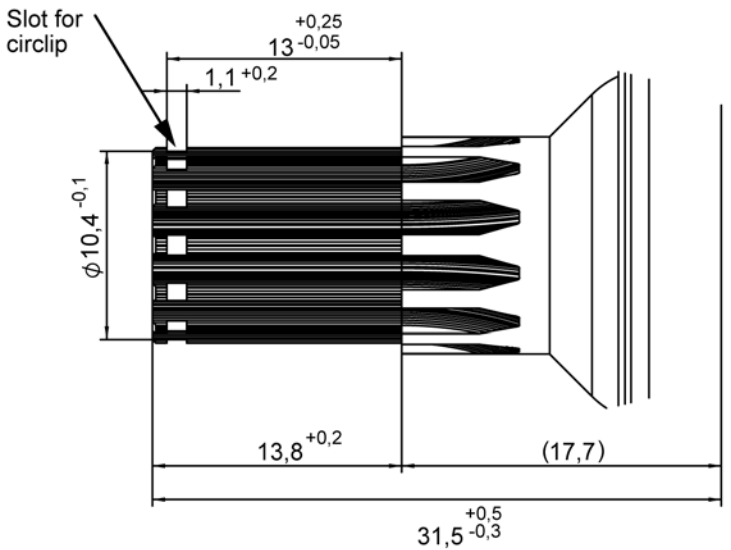

Spline on Shaft: DIN 5480 - W11x0,8x30°x12x7h

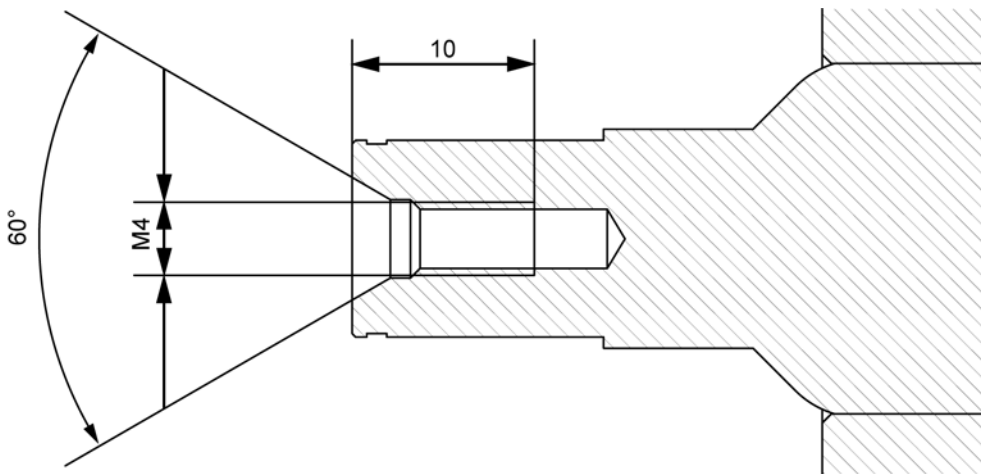

## 6.2 Cooling circuit

NOTICE	
<b>Material Damage!</b>	<p><b>Material damage due to overheating!</b></p> <p>The drive system is intended solely for operation in a closed cooling circuit with a heat exchanger. Operation without the specified liquid cooling system is not permitted. The drive system will overheat, causing it to be destroyed.</p> <p><b>Preventive measures:</b></p> <ul style="list-style-type: none"> <li>• Only operate the drive system with the specified cooling system</li> <li>• Connect the PTC thermistor from the servo motor to the temperature monitoring equipment</li> <li>• Activate the I<sup>2</sup>t monitoring of the servo motor in ID32773 'Service bits', bit 14</li> </ul>

NOTICE	
<b>Material Damage!</b>	<p><b>Material damage due dew forms!</b></p> <p>When the surface temperature of the cooling plate or the cooled motors drops below the dew point, the water which bound in the air, condenses on the surface. The dew point depends on the ambient temperature and the humidity.</p> <p><b>Preventive measures:</b></p> <ul style="list-style-type: none"> <li>• The flow temperature of the coolant must be designed based on the dew point table so that the surface temperatures of the cooling plate and the cooled motors do not fall below the dew point and there is therefore no condensation. (see dew point table)</li> </ul>

⚠ WARNING	
	<p><b>Warning against pressurised lines!</b></p> <p>Closed cooling circuits are under high pressure. Opening the circuit while it is under high pressure can result in injuries from escaping coolant. The sudden pressure change can cause lines to rip loose or make uncontrolled movements.</p> <p><b>Steps to prevent:</b></p> <ul style="list-style-type: none"> <li>• Never open a line system that is under high pressure!</li> <li>• Drain the coolant at the provided point, e.g. drain valve. Pay attention to the instructions of the manufacturer of the cooling device.</li> <li>• Collect the cooling liquid in a proper containment. Store or dispose it according to the local instructions.</li> <li>• Wear adequate protective clothing, e.g. goggles, gloves, safety shoes.</li> </ul>

### 6.2.1 Liquid cooling motor

NOTICE	
<b>Material Damage!</b>	<p><b>Material damage due to overheating!</b></p> <p>The motor is intended solely for operation in a closed cooling circuit with a heat exchanger. Operation without the specified liquid cooling system is not permitted. The motor will overheat. The insulation in the motor is impaired or destroyed. Overheated permanent magnets are permanently weakened.</p> <p><b>Preventive measures:</b></p> <ul style="list-style-type: none"> <li>• Only operate the motor with the specified liquid cooling system</li> <li>• Connect the PTC thermistor from the servo motor to the temperature monitoring equipment</li> <li>• Activate the I<sup>2</sup>t monitoring of the servo motor in ID32773 'Service bits', bit 14</li> </ul>



The motor is delivered without a cooling jacket.  
The cooling jacket for the motor must be designed and constructed by the user.

#### Minimum requirements:

The specified rated data (see: Motor\_data\_sheet\_A2370DD\_DD5) are only under the following conditions:

- Maximum flow temperature: 40 °C (104 °F) (derating: from 40 °C (104 °F) to 60 °C (140 °F) 1% per 1K)
- The minimum flow rate 4 l/min (1.06 Oz/min)
- The maximum temperature increase of the coolant <5K

NOTICE	
<b>Material Damage!</b>	<p><b>Material damage due dew forms!</b></p> <p>When the surface temperature of the cooled motors drops below the dew point, the water which bound in the air, condenses on the surface. The dew point depends on the ambient temperature and the humidity.</p> <p><b>Preventive measures:</b></p> <ul style="list-style-type: none"> <li>• The flow temperature of the coolant must be designed based on the dew point table so that the surface temperatures of the cooled motors do not fall below the dew point and there is therefore no condensation. (see dew point table)</li> </ul>

#### Cooling area motor

The power losses  $P_V$  arises mainly in copper (the electrical conductors) and in iron (the magnetic conductors). The better the thermal losses is dissipated, more torque and thereby more power can generate.

The liquid cooling jacket and the cooling system must be designed and constructed by the user.

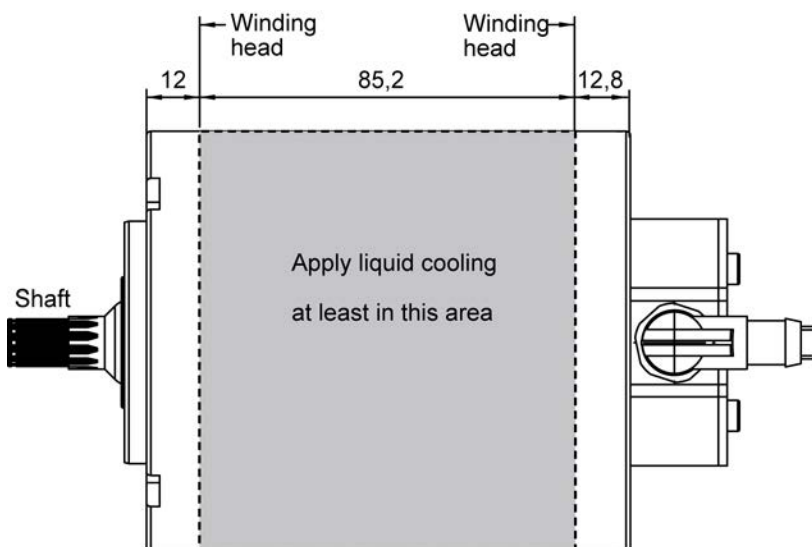



### Thermal losses at the motor

The thermal losses  $P_V$  are calculated as follows:

- M Torque
- n Speed
- Efficiency



The torque, speed, and efficiency can be obtained from the efficiency curve on the motor data sheet.

In the case of liquid-cooled motors, the power loss that can be dissipated is proportional to the flow rate of the coolant. The minimum coolant flow rate over a period of time is calculated as follows:

- $\Delta T$ : Permissible temperature increase of the coolant between flow and return  $\Delta T < 5 \text{ }^\circ\text{K}$
- C: Specific thermal capacity of the coolant, e.g., water:  $4187 \text{ J}/(\text{kg}\cdot\text{K})$

## 6.2.2 Liquid cooling inverter

NOTICE	
<b>Material Damage!</b>	<p><b>Material damage due to overheating!</b></p> <p>The inverter is intended solely for operation in a closed cooling circuit with a heat exchanger. Operation without the specified liquid cooling system is not permitted. The inverter will overheat, causing it to be destroyed.</p> <p><b>Preventive measures:</b></p> <ul style="list-style-type: none"> <li>• Only operate the drive system with the specified cooling system</li> </ul>

The liquid-cooled cold plate is used to dissipate the power loss from the power electronics of the inverters.

The cold plate consists of a heat sink made from an AlMgSi 0.5 aluminum alloy with an integrated cooling channel. The heat is dissipated via the water that is routed through the cold plate.

The surface temperature of the liquid-cooled cooling plate must be  $< 40 \text{ }^\circ\text{C}$  ( $104 \text{ }^\circ\text{F}$ ).

NOTICE	
<b>Material Damage!</b>	<p><b>Material damage due dew forms!</b></p> <p>When the surface temperature of the cooling plate drops below the dew point, the water which bound in the air, condenses on the surface. The dew point depends on the ambient temperature and the humidity.</p> <p><b>Preventive measures:</b></p> <ul style="list-style-type: none"> <li>• The flow temperature of the coolant must be designed based on the dew point table so that the surface temperatures of the cooling plate not fall below the dew point and there is therefore no condensation. (see dew point table)</li> </ul>

### Minimum requirements:

The specified rated data (see: chapter 'Technical data - inverter') are only under the following conditions:

- Maximum flow temperature:  $25 \text{ }^\circ\text{C}$  ( $77 \text{ }^\circ\text{F}$ )
- The minimum flow rate:  $10 \text{ l}/\text{min}$  ( $2.64 \text{ Oz}/\text{min}$ )
- Pressure:  $1.5 \text{ bar}$  ( $21.76 \text{ psi}$ )
- The maximum temperature increase of the coolant  $< 5\text{K}$



The power loss from the control electronics is not dissipated via the cold plate.  
 The ambient temperature must not  $> 40 \text{ }^\circ\text{C}$  ( $104 \text{ }^\circ\text{F}$ ).  
 The heat that arises has to be extracted separately.

### Technical data for the FSE cold plate:

Maximum power that can be dissipated <sup>1)</sup>	2,000 watts
Water flow	1.5 bar (21.76 psi); 10 l/min (2.64 Oz/min)
Ambient temperature during operation	+5 °C (41 °F) to +40 °C (104 °F)
Relative humidity	5% to 85%, non-condensing
Coolant pipe material	AlMgSi 0.5
Dimensions	339 x 180 mm
Coolant connection	G 1/4" internal thread
Test pressure	8 bar (116 psi)

1) At 25 °C (41 °F) and 10 l/min (2.64 Oz/min)

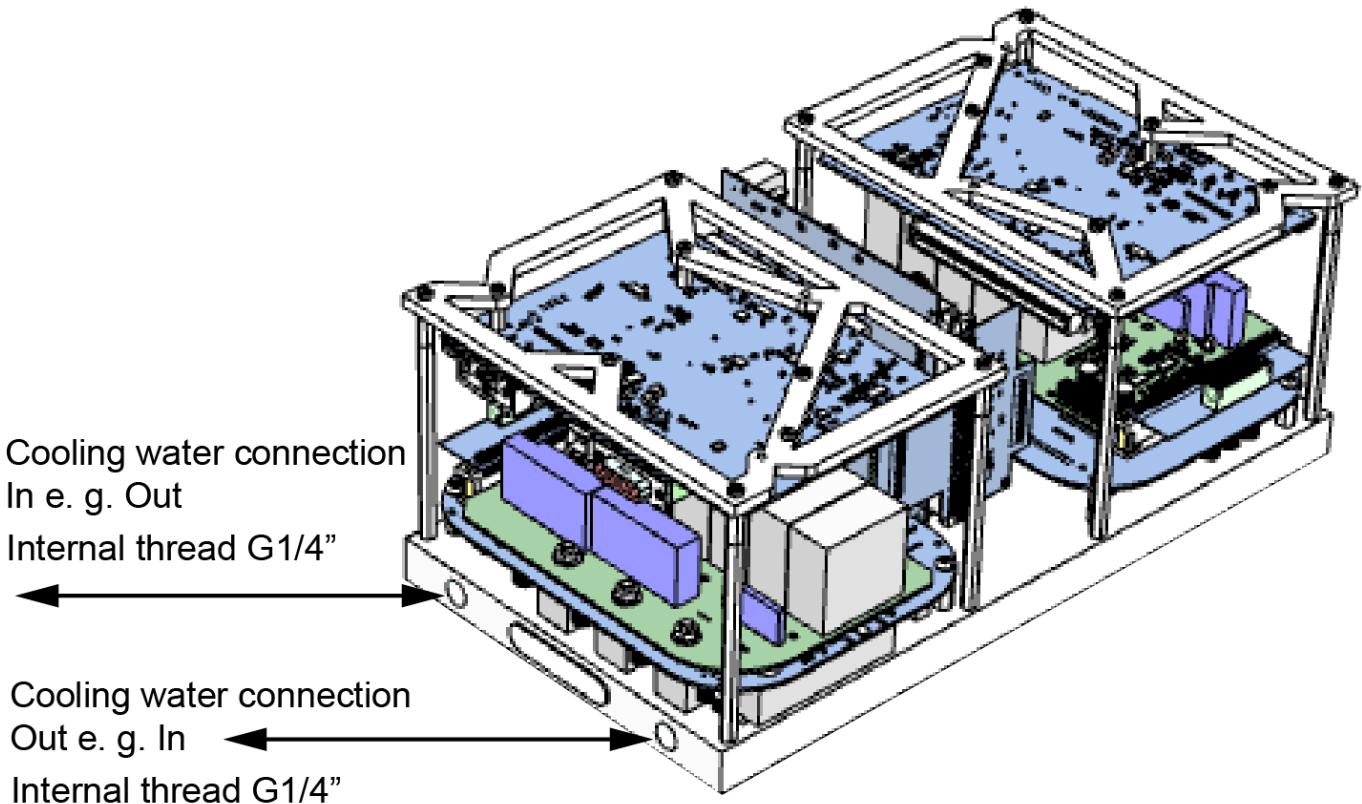

The illustration shows the cooling channel in the cold plate.

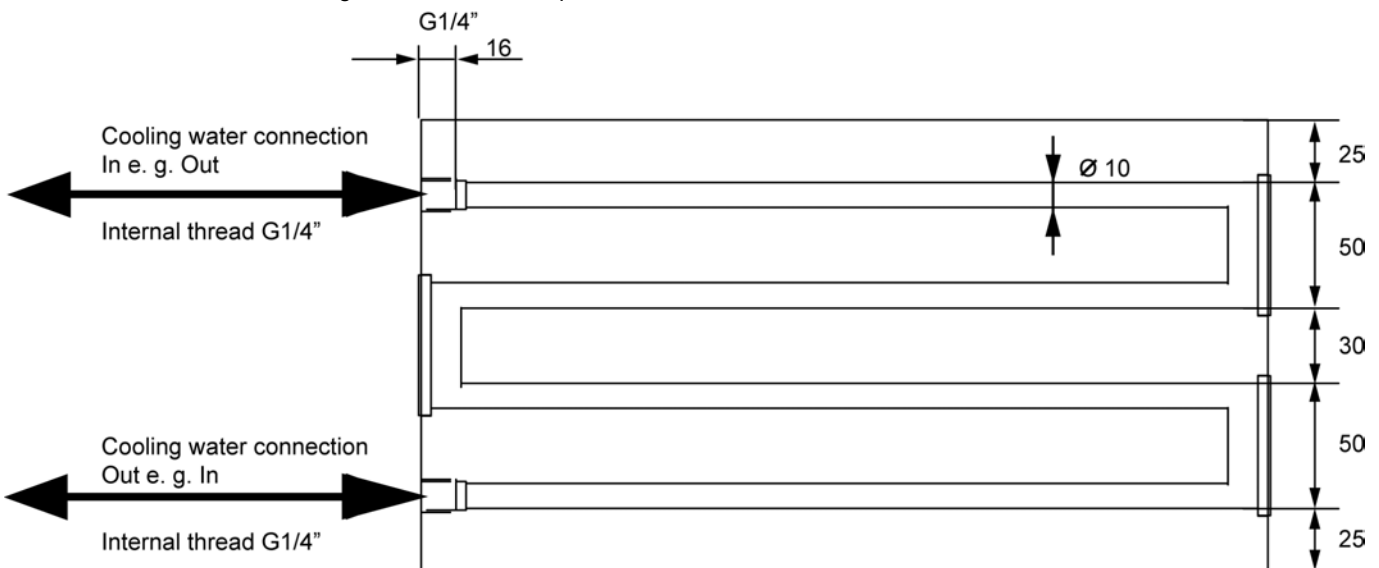

## Installing the cooling circuit

### Montage

#### Requirements for the cooling circuit

NOTICE	
<b>Material Damage!</b>	<p><b>Damage to the cooling plate/stator housing due to electrolysis</b></p> <p>The cooling plate is made of an aluminum alloy AlMgSi0.5, the stator housing made of AlZnMgCu1.5. If components such as supply line pipes and heat exchangers that are made of more precious materials (e.g. copper) are used within the cooling circuit, they can be affected and damaged due to electrolytic processes.</p> <p><b>Steps to prevent:</b></p> <ul style="list-style-type: none"> <li>• Only use components made of the same or a comparable aluminium alloy within the cooling circuit</li> </ul>

The coolant is connected from the side using two G 1/4" internal threads and the corresponding hose fittings.

Tightening torque for G 1/4": max. 20 Nm

### Cooling liquid

The following guide values apply to the quality of the circulating water in cold water systems:

- pH value 7-9
- Electrical conductivity < 300 mS / m
- A corrosion inhibitor (e.g. Nalco 77381 from Nalco Deutschland GmbH) must be added to the cooling water
- If necessary, water additives should be used as frost protection and against algae formation
- In general, the regulations of the heat exchanger manufacturer apply

### 6.2.3 Dew point table

NOTICE	
<b>Material Damage!</b>	<p><b>Material damage when dew forms!</b></p> <p>Dew may result in electrical shorts.</p> <p><b>Steps to prevent:</b></p> <ul style="list-style-type: none"> <li>• Observe the dew point table!</li> <li>• Switch off the cooling circuit when the systems are idle!</li> <li>• Check the temperature of the coolant after longer downtimes!</li> <li>• At high levels of humidity, it is recommended to use a dehumidifier!</li> </ul>

The dew point table specifies at which surface temperature condensate forms. This depends on the temperature of the air and the relative humidity.

#### Dew point table in °C

**Example:** Ambient temperature: 32 °C, humidity: 60 %  
 The temperature of the cooling circuit may not be less than 23 °C, else condensate will form!

Ambient air temperature in °C	Dew point in °C at a relative humidity of										
	45%	50%	55%	60%	65%	70%	75%	80%	85%	90%	95%
2	-7.70	-6.26	-5.43	-4.40	-3.16	-2.48	-1.77	-0.98	-0.26	0.47	1.20
4	-6.11	-4.88	-3.69	-2.61	-1.79	-0.88	-0.09	0.78	1.62	2.44	3.20
6	-4.49	-3.07	-2.10	-1.05	-0.08	0.85	1.86	2.72	3.62	4.48	5.38
8	-2.69	-1.61	-0.44	0.67	1.80	2.83	3.82	4.77	5.66	6.48	7.32
10	-1.26	0.02	1.31	2.53	3.74	4.79	5.82	6.79	7.65	8.45	9.31
12	0.35	1.84	3.19	4.46	5.63	6.74	7.75	8.69	9.60	10.48	11.33
14	2.20	3.76	5.10	6.40	7.58	8.67	9.70	10.71	11.64	12.55	13.36
15	3.12	4.65	6.07	7.36	8.52	9.63	10.70	11.69	12.62	13.52	14.42
16	4.07	5.59	6.98	8.29	9.47	10.61	11.68	12.66	13.63	14.58	15.54
17	5.00	6.48	7.62	9.18	10.39	11.48	12.54	13.57	14.50	15.36	16.19
18	5.90	7.43	8.83	10.12	11.33	12.44	13.48	14.56	15.41	16.31	17.25
19	6.80	8.33	9.75	11.09	12.26	13.37	14.49	15.47	16.40	17.37	18.22
20	7.73	9.30	10.72	12.00	13.22	14.40	15.48	16.46	17.44	18.36	19.18
21	8.60	10.22	11.59	12.92	14.21	15.36	16.40	17.44	18.41	19.27	20.19
22	9.54	11.16	12.52	13.89	15.19	16.27	17.41	18.42	19.39	20.28	21.22
23	10.44	12.02	13.47	14.87	16.04	17.29	18.37	19.37	20.37	21.34	22.23
24	11.34	12.93	14.44	15.73	17.06	18.21	19.22	20.33	21.37	22.32	23.18
25	12.20	13.83	15.37	16.69	17.99	19.11	20.24	21.35	22.27	23.30	24.22
26	13.15	14.84	16.26	17.67	18.90	20.09	21.29	22.32	23.32	24.31	25.16
27	14.08	15.68	17.24	18.57	19.83	21.11	22.23	23.31	24.32	25.22	26.10
28	14.96	16.61	18.14	19.38	20.86	22.07	23.18	24.28	25.25	26.20	27.18
29	15.85	17.58	19.04	20.48	21.83	22.97	24.20	25.23	26.21	27.26	28.18
30	16.79	18.44	19.96	21.44	23.71	23.94	25.11	26.10	27.21	28.19	29.09
32	18.62	20.28	21.90	23.26	24.65	25.79	27.08	28.24	29.23	30.16	31.17
34	20.42	22.19	23.77	25.19	26.54	27.85	28.94	30.09	31.19	32.13	33.11
36	22.23	24.08	25.50	27.00	28.41	29.65	30.88	31.97	33.05	34.23	35.06
38	23.97	25.74	27.44	28.87	30.31	31.62	32.78	33.96	35.01	36.05	37.03
40	25.79	27.66	29.22	30.81	32.16	33.48	34.69	35.86	36.98	38.05	39.11
45	30.29	32.17	33.86	35.38	36.85	38.24	39.54	40.74	41.87	42.91	44.03
50	34.76	36.63	38.46	40.09	41.58	42.99	44.33	45.55	46.75	47.90	48.98

The use of a dehumidifier in the switch cabinet is recommended in case of high levels of humidity.



## 6.3 Electric

### 6.3.1 Charging and discharging the HV circuit capacitors

The HV circuit capacitors in the inverters must be charged and discharged via an external charging device.

The HV circuit capacity is 300 µF in total (75 µF per inverter).

The charging- and discharging device does not part of the RACING KIT and must be designed by the user.

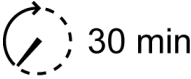
 <b>DANGER</b>	
 	<p><b>Danger to life from electric shock!</b></p> <p>After switching off the HV circuit, the buffer capacitors for the DC bus can still have a charge and lead to a life-threatening DC voltage if they are not discharged via an external circuit.</p> <p><b>Steps to prevent:</b></p> <ul style="list-style-type: none"> <li>• Prior to all work on the device, the HV power supply is to be separated from the main switch and secured against restarting.</li> <li>• After switching off, expect a discharge time of at least 30 minutes.</li> <li>• Measure the terminal voltage, e.g. in the HV DC bus between the HV+ and HV- terminals to ensure that the terminal is voltage-free.</li> <li>• Caution: A voltage-free state is not signalled!</li> <li>• Use external discharge circuit. <a href="#">Siehe 'Calculation example – discharging circuit' auf Seite 30.</a></li> </ul>

#### 6.3.1.1 Calculation example – charging circuit

5 capacitors (each 15 µF) are connected in parallel for each inverter.

Maximum pulse peak per capacitor: 240 A

Effective current per capacitor (at 10 kHz): 10.5 A

##### Calculation example:

$U_0 = 500 \text{ V}$	$U_0 = \text{HV battery voltage (DC circuit voltage)}$
$t = 0.2 \text{ s}$	$t = \text{Charging time via charging resistor (predefined)}$
$R = 100 \text{ ohms}$	$R = \text{Charging resistance (predefined)}$
$C = 300 \text{ µF}$	$C = \text{DC circuit capacity (5 x 15 µF x 4 inverters)}$
$T = R \times C (T = 0.03 \text{ s})$	$T = \text{Time constant}$

Capacitor voltage

Voltage at charging resistor

Voltage at charging resistor

Effective charging current

Charging energy

Charging energy

Peak power

Average power

When  $T = 5$  ( $5 T = 5 \times 0.03 \text{ s} = 0.15 \text{ s}$ ), the capacitors are charged by 99.33% of  $U_0$ . Reserves of 0.05 s are available. The selected 100 ohm resistor must be designed for an average power of 3.75 watts and a peak power of 187.5 watts.

### 6.3.1.2 Calculation example – discharging circuit

Calculating an active discharge for the quad inverter by using of 3 watts of power resistors.

5 capacitors (each 15  $\mu\text{F}$ ) are connected in parallel for each inverter.

The discharge circuit should be activated with a normally open switch contact, if the HV circuit or the battery is disconnected.

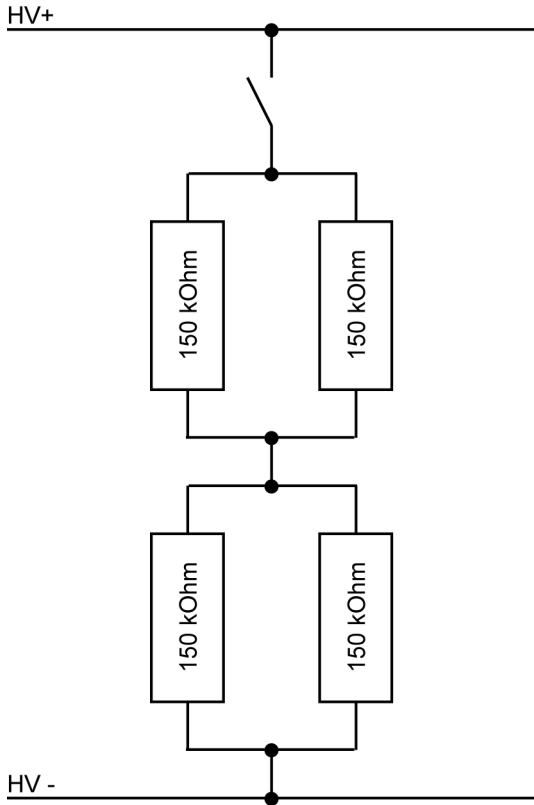

**Calculation example:**

$U_0$  = 600 V  
 $R_1, R_2, R_3, R_4$  = 150 kOhm  
 $C$  = 300  $\mu\text{F}$

$U_0$  = HV battery voltage (DC circuit voltage)  
 $R$  = Discharging resistance (predefined)  
 $C$  = DC circuit capacity (5 x 15  $\mu\text{F}$  x 4 inverters)

- Total resistance
- Discharge current
- Maximum power loss all resistors
- Maximum power loss each resistors
- Time constant

**Discharge time to prescribed residual voltage  $U_c$**

$U_c$  = 50 V                       $U_c$  = Residual voltage at capacitor  
 $\ln$  = Logarithm naturalis

Discharge time in seconds until residual voltage  $U_c$  is reached

Discharge time in minutes until residual voltage  $U_c$  is reached

Result:

With active discharge according to the calculation example a discharge time of 111.821 s (1.86 min) is needed, to be discharged to a residual voltage of 50 VDC.

**Residual voltage to prescribed discharge time t**

$t = 300$  s                       $t =$  Discharge time

Result:

After 300 s discharge time, the residual voltage is 1 volt.

**6.3.2 PE ground connection – overview**

A highly conductive connection must be implemented in the vehicle to provide the ground connection. This is used as a 0 VDC ground for all signal and operating voltages. For vehicles without a metal frame, a ground strap made from a braiding of fine copper wires can be used.

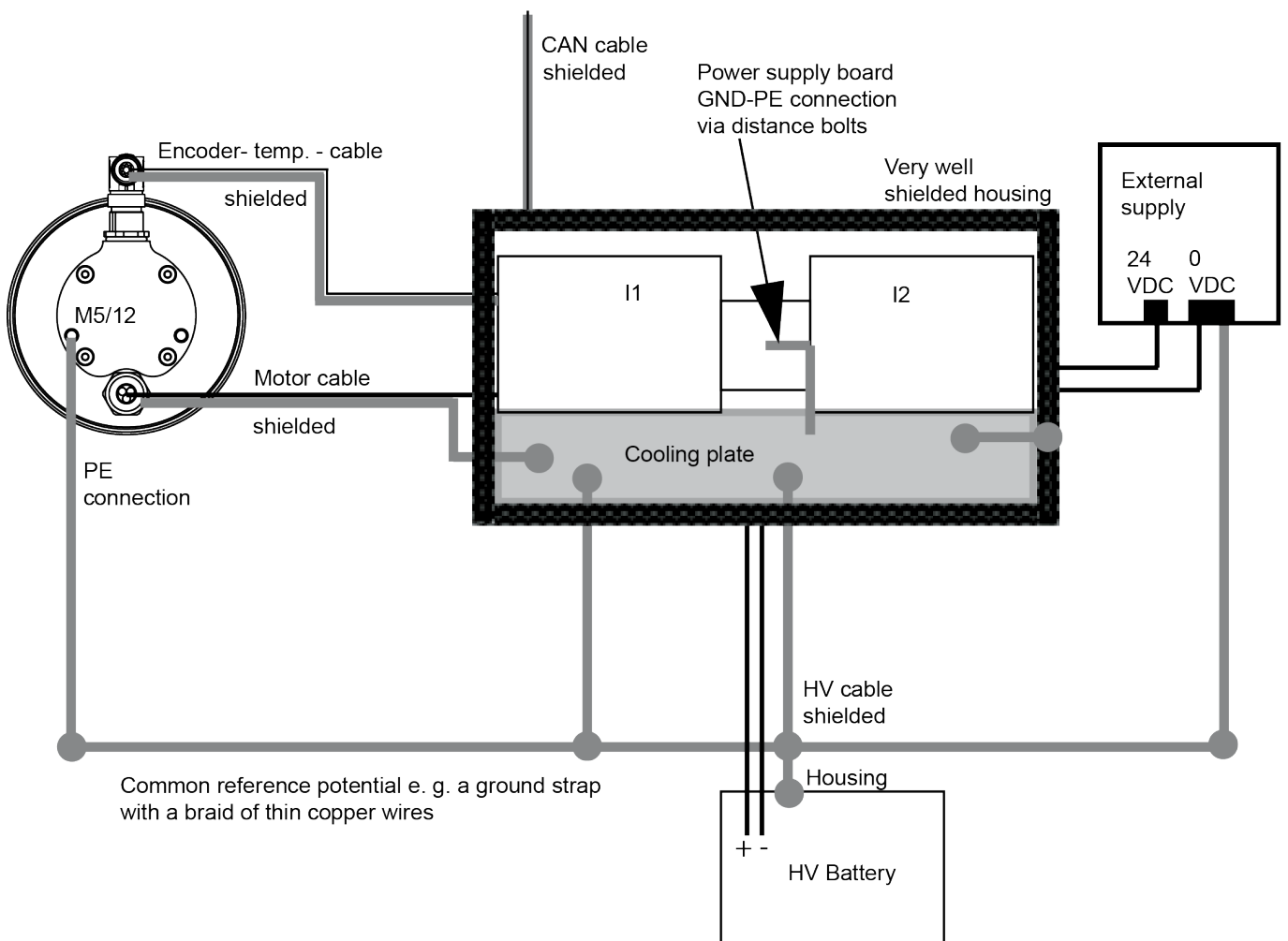

**Motor cable**

The motor cable must be a shielded cable with tinned copper braiding. The motor cable shield must be connected to the shield for the unconnected cable end of the motor across the surface. Use non-adhesive heat-shrink tubing for this. Press the two pieces of shielding firmly together.

At the inverter, the shield must be placed across the surface of the cold plate. Ensure good contact with the cold plate.



The motor cable shield can prevent interference to a large extent.  
(Large diameter → skin effect)

**HV cable**

When greater than 1 m, the HV cable must have a copper shield.

The end of the shield must be connected to the designated casing ground on the cold plate and on the battery side.



The end of the shield must NOT be connected to the negative terminal (-) of the HV battery.

**Encoder temp. cable**

The encoder cable shield must be grounded on both sides.

Via the circular connector casing on the motor and via the metalized D-SUB casing on the inverter (connection X131).

**Power supply board**

The power supply board GND is connected to the cold plate via the standoffs.

**Cold plate**

The cold plate must be connected to the common vehicle ground.

**External power supply**

The 0 VDC connection must be connected to the common vehicle ground.



### 6.3.2.1 GND and PE connection – power supply and logic board

The cold plate is the PE ground for the inverters. The user is responsible for connecting the cold plate to the vehicle PE with a cable strand/ground strap (10 mm<sup>2</sup>). The user is responsible for producing the PE connection point on the cold plate. The user can choose where to place the connection point between the cooling channel. The cooling channel must not be damaged when pre-drilling the connection screw for the PE connection. [Siehe 'Liquid cooling inverter' auf Seite 25.](#)

The 0 VDC connection for an external 24 VDC power supply must also be connected to the vehicle PE by the user.

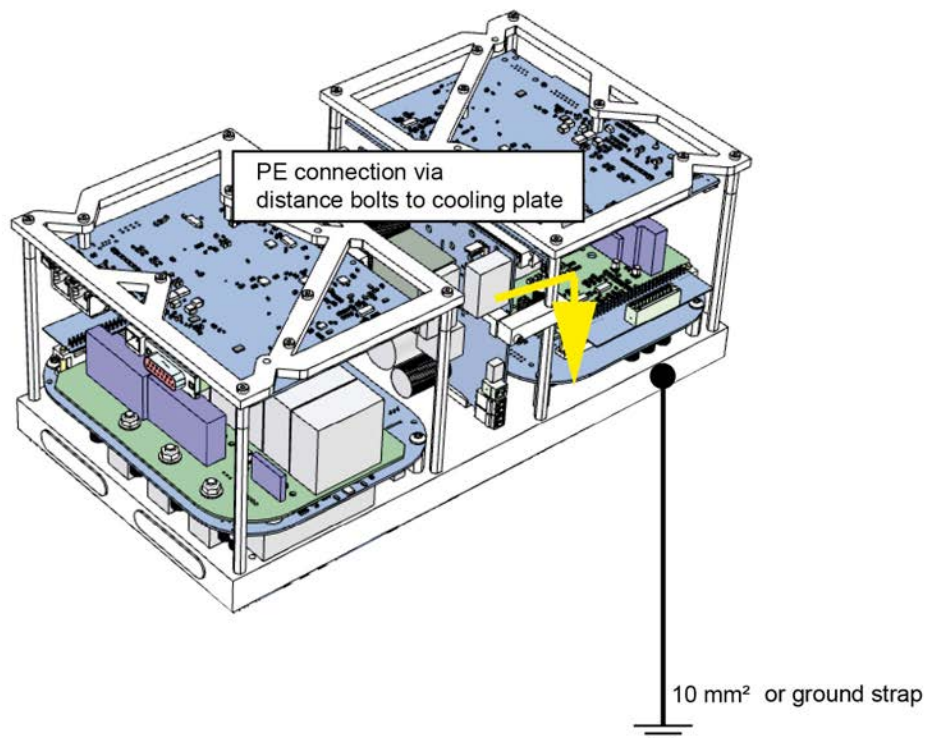
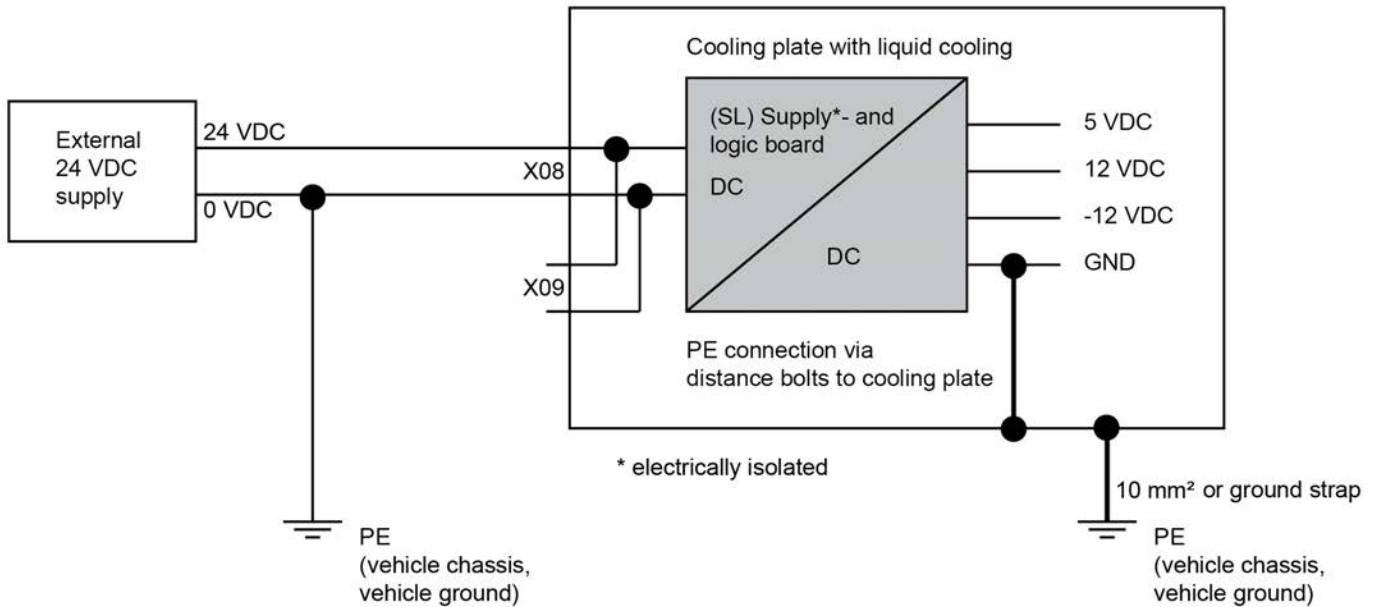

## 6.4 Configuration

All AMKmotion parameters are based on the SERCOS® standard and are described as identification (ID) numbers. They are described in the Parameter description KW-R25. (See AIPEX PRO → menu → '?' → Parameter description → KW-R25)

The inverter parameters are configured using the AMKmotion AIPEX PRO startup software.



The FSE function is a special item of firmware in which some of the functionality and setting options for the parameters differ from the default parameter description and the selection options in AIPEX PRO.

Please refer to the following chapters for settings relevant to the FSE function.

### 6.4.1 Motor parameters



When the system is started up for the first time, the motor parameters are automatically transferred from the encoder database to the inverter.

The function is not performed if the motor parameters have already been entered manually. The AIPEX PRO's 'Initial program loading' (PW: 500591) function in direct mode allows the factory settings from AMK to be restored.

Prerequisite for the automatic transfer of the data from the encoder database:

- Encoder cable connected
- Motor parameters have not already been changed manually
- The data has been stored in the encoder at the factory

### 6.4.2 Communication parameters CAN bus

Siehe 'CAN Bus communication' auf Seite 61.

### 6.4.3 FSE parameters

ID32798 'User list 1'



ID32798 'User list 1' is used to configure the torque limitation when operating within limits. For description of function:

Siehe 'Torque limitation' auf Seite 85.

The user list must be configured on both a user-specific <sup>1)</sup> and device-specific <sup>2)</sup> basis.

ID element	Dec value	Name	Scaling	Meaning
32798 - 2	1 <sup>2)</sup>	Mode	-	Operating mode (FSE = 1)
32798 - 3	720 <sup>1,2)</sup>	HV max	V	Maximum battery voltage (end-of-charge voltage) (user-specific value, max. 720 VDC)
32798 - 4	250 <sup>1,2)</sup>	HV min	V	Minimum battery voltage (deep discharge) (user-specific value, min. 250 VDC)   The value in ID32837 'DC bus voltage monitoring' must be adapted to ID32798 - 4 'Minimum battery voltage'.
32798 - 5	500 <sup>2)</sup>	InvTempMaxTorque	0.1 °C	Inverter temperature up to which full torque is available
32798 - 6	650 <sup>2)</sup>	InvTempMinTorque	0.1 °C	Inverter temperature at which no torque is available (Automatic switch-off temperature inverter with error message = 65°C)
32798 - 7	670 <sup>1,2)</sup>	HVMaxTorqueDeceleration	V	Start of reduction for end-of-charge voltage (user-specific value, at least 5% below the maximum battery voltage (ID32798 - 3). If oscillation occurs, a value > 5% must be selected)
32798 - 8	1150 <sup>2)</sup>	IgbtTempMaxTorque	0.1 °C	Power supply temperature up to which full torque is available

ID element	Dec value	Name	Scaling	Meaning
32798 - 9	1250 <sup>2)</sup>	IgbtTempMinTorque	0.1 °C	Power supply temperature at which no torque is available (Maximum value 125 °C)
32798 - 10	300 <sup>1,2)</sup>	HVMaxTorqueAcceleration	V	Start of reduction for deep discharge protection (user-specific value, at least 20% higher than the minimum battery voltage (ID32798 - 4)).
32798 - 11	1250 <sup>2)</sup>	MotorTempMaxTorque	0.1 °C	Motor temperature up to which full torque is available
32798 - 12	1400 <sup>2)</sup>	MotorTempMinTorque	0.1 °C	Motor temperature at which no torque is available (Automatic switch-off motor temperature with error message = 140 °C)

### Configuring the user list

Convert the user list type from hexadecimal 'Hex' to decimal 'Dec' view.

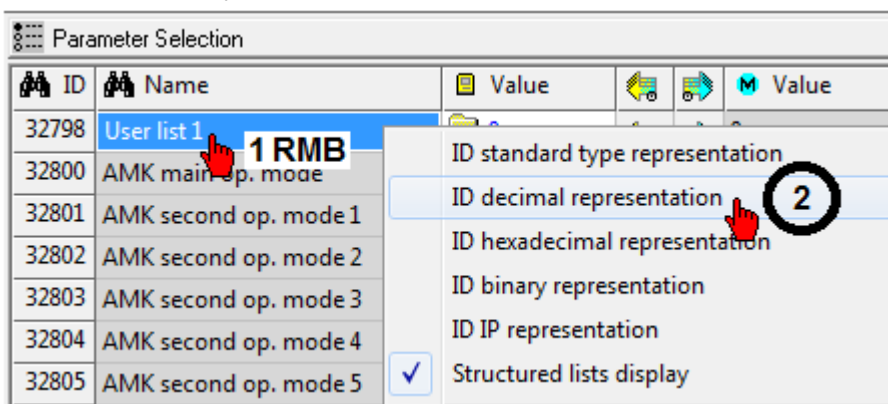

Enter the length of the list (maximum length of the list 245).

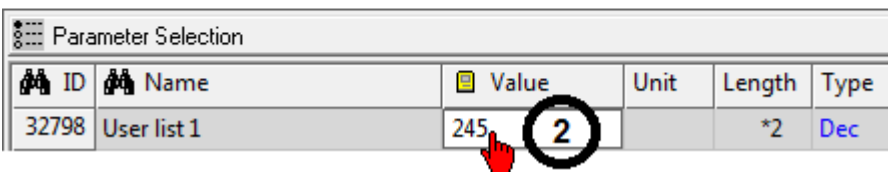
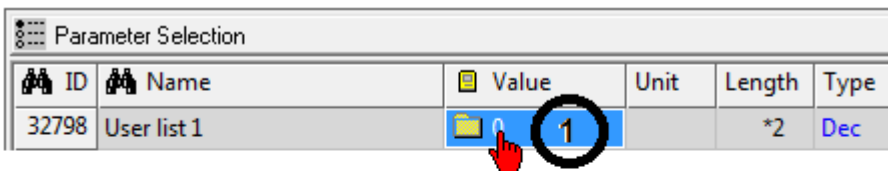

Click the 'Folder' icon to open the list.

You can then enter the predefined values in the list elements.

Parameter Selection						
ID	Name	Value	Unit	Length	Type	
32798	User list 1	245		*2	Dec	1
32798-1	[maximum]	[24]				
32798-2		1			Dec	
32798-3		800			Dec	
32798-4		300			Dec	
32798-5		500			Dec	
32798-6		0			Dec	2

### 6.4.4 Default parameters

The 'Operating mode parameters' group is used to set the main operating mode.

ID32800 'AMK main operating mode'

Default value: 0x3C0043

**Torque control:**

Input value: 0x480002 (meaning: torque control with torque limitation as per ID82/83, setpoint source 0x48)

**Speed control:**

Input value: 0x480003 (meaning: speed control with torque limitation as per ID82/83, setpoint source 0x48)

The 'System parameters' group is used to set the controller enable RF source hardware.

ID32796 'Source RF'

Default value: 0 dec

Input value: 5 dec (meaning: RF via fieldbus)



To activate the motor control you always need the following 4 signals:

- RF hardware signal (X140 DI1)
- CAN Signal AMK\_bEnable
- CAN Signal AMK\_bQuitDcOn
- CAN Signal AMK\_bInverterOn.

The 'System parameters' group is used to activate the FSE special function.

ID32901 'Global service bits'

Default value: 0x240

Input value: 0x10240 (meaning: FSE special function active)

The 'General parameters' group is used to activate I<sup>2</sup>t motor monitoring.

ID32773 'Service bits'

Default value: 0000 0000 0000 0000 0001 0000 0000 0101 (0x1005)

Input value: 0000 0000 0000 0000 0101 0000 0000 0001 (0x5001)

Bit 2 = 0 Motor deceleration control with RF withdrawal

Bit 14 = 1 I<sup>2</sup>t motor monitoring active

The 'Motor parameters' group is used to enter the maximum speed.

ID113 'Maximum speed'

Default value: 6000

Input value: application-specific



If the actual speed value increases to the value in ID113 x 1.25, the output stage is blocked automatically and the motor runs down. The user must define the value for ID113 subject to the process without exceeding the maximum speed of the motor.

The 'Speed controller parameters' group is used to enter the speed limit.

ID38 'Positive velocity limit'

ID39 'Negative velocity limit'

Default value: +(-) 5000

Input value: application-specific (meaning: ID38/ID39 limits the speed setpoint)

The 'Inverter parameters' group is used to enter minimum allowed battery voltage.

ID32837 'DC bus voltage monitoring'

Default value: device specific

Input value: ID32798 - 4 'Minimum allowed battery voltage'

Exceeds the HV voltage the value in ID32798 - 4, the internal signal AMK 'QUE' will be set and the motor control can be activated.

### 6.4.4.1 IO Parameter

The controller card has an interface (X140) with 3 multifunctional IO pins. The FSE firmware accesses the IOs directly.

The associated parameters must be parameterized with the value 0.

Input values:

PIN	Parameter	Value
DO1 / DI1	ID32865 'Port 3 Bit 0'	0
	ID32978 'Port 3 Bit 0'	0
DO2 / DI2	ID32866 'Port 3 Bit 1'	0
	ID32979 'Port 3 Bit 1'	0
DO3 / DI3	ID32867 'Port 3 Bit 2'	0
	ID32980 'Port 3 Bit 2'	0

### 6.4.5 Direction of rotation for motor shaft

If the setpoint is positive, the motor rotates in a clockwise direction (default setting) when looking at the motor shaft (A bearing side).

To reverse the direction of rotation without having to alter the coordinate view of setpoints and actual values, reverse the polarity of the setpoints and actual values by setting ID32773 'Service bits' bit 16 = 1.

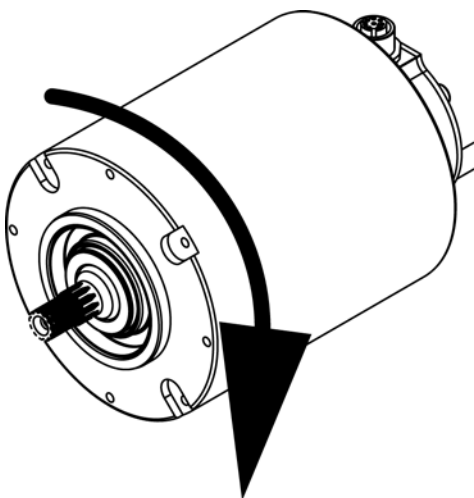

ID32773 Bit16 = 0

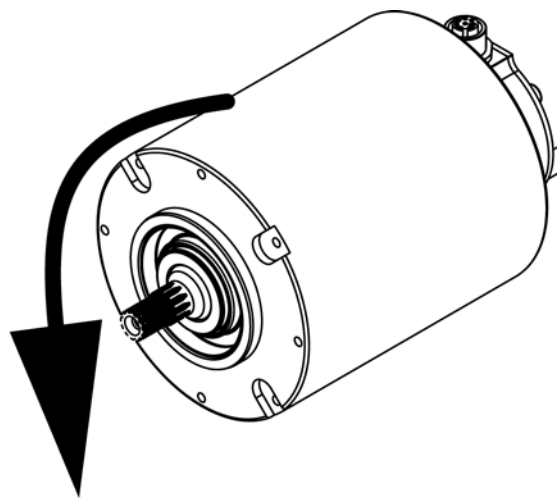

ID32773 Bit16 = 1

## 6.5 Synchronous servo motor with and without field weakening

### 6.5.1 Synchronous servo motor without field weakening

For a synchronous servo motor the maximum motor torque value is available up to the 'characteristic speed point' .

After the 'characteristic speed point' the maximum motor torque decreases with increasing speed. When the motor reach the theoretical no-load-speed, the motor torque is 0 Nm.

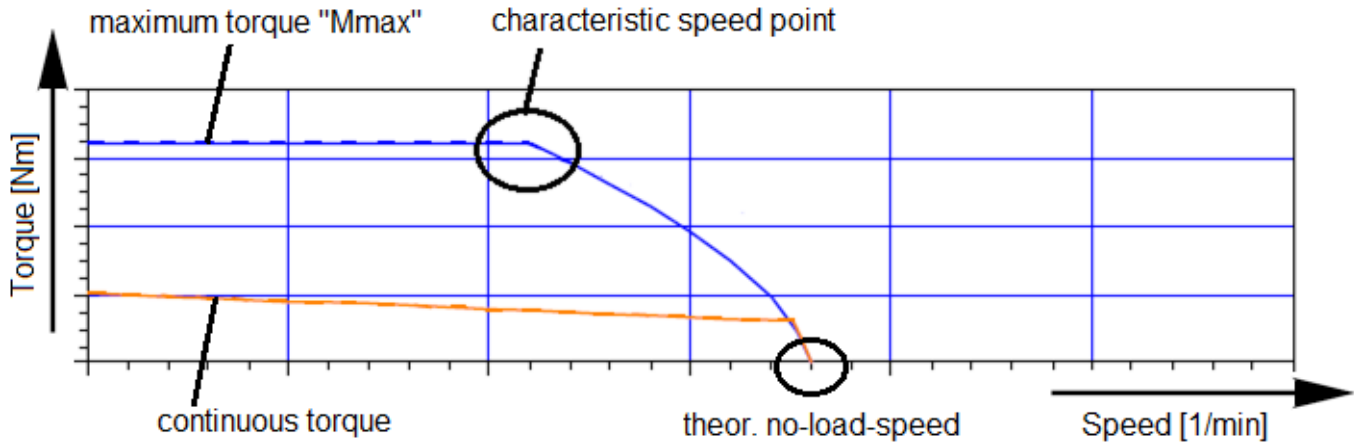

This is due to with the speed increasing induced voltage of the motor.

When approaching the induced voltage at the maximum output voltage of the inverter, the torque-generating current  $I_q$  reduced. Sequence, the motor torque decreases.

The maximum output voltage of the inverter is limited by the HV voltage.

When operating points on the 'characteristic speed point', the control reserve for the current controller is severely limited.

If you are using a battery, the HV voltage can vary by acceleration or recuperation. The HV voltage has a direct influence on the 'characteristic speed point' .

The induced voltage can be calculated using the following formula:

### 6.5.2 Synchronous servo motor with field weakening

A synchronous servo motor with field weakening can reach higher speeds with simultaneously, slowly reducing engine torque.

In addition, control reserves be achieved in the area of 'characteristic speed point'.

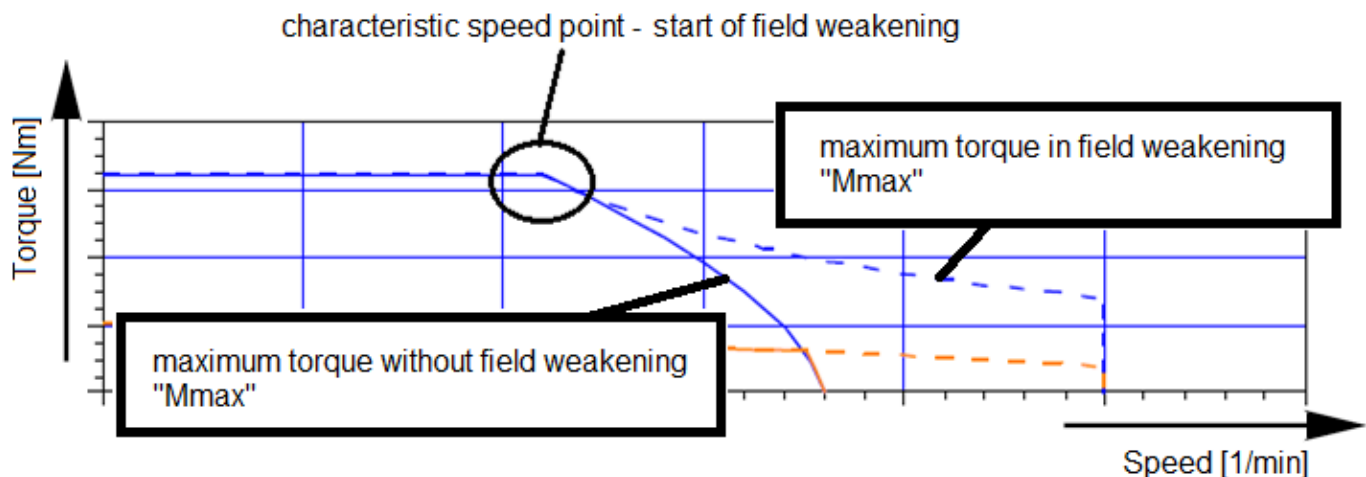

During the transition to the field weakening, the inverter injects in the winding a negative field weakening current  $I_d$ .

Thereby, the field of the permanent magnet is weakened. The 'voltage constant  $K_e$ ' decreases, which reduces the induced voltage.

A torque-generating current  $I_q$  can flow.



The negative field weakening current  $I_d$  caused losses. The maximum motor current " $I_{max}$ " must not be exceeded.

### 6.5.3 Characteristics of motor power and motor torque



The following illustrations are exemplary characteristics.

The maximum motor power depends on the available HV voltage.

Example: Motor power at 600 VDC and 500 VDC / - - - field weakening area

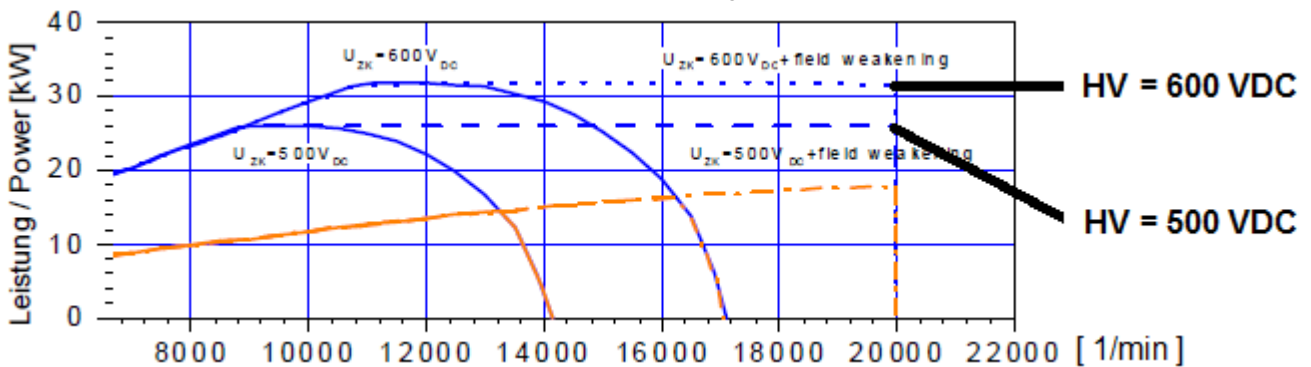

The transition into the field weakening (characteristic speed point) collaborates with reduced HV voltage earlier.

The maximum motor torque falls generally in field weakening. In addition, the torque falls with reduced HV voltage.

Example: Motor torque at 600 VDC and 500 VDC / - - - field weakening area

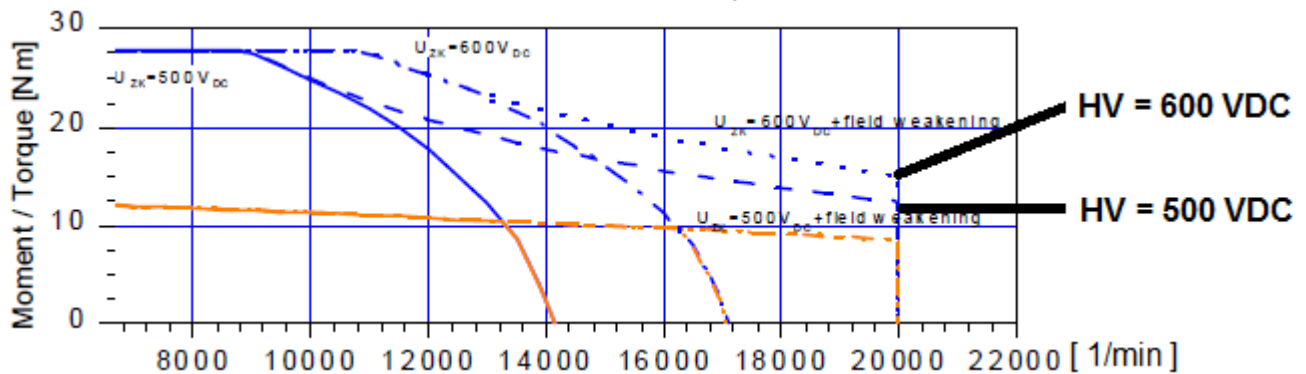

### 6.5.4 Torque setpoint in field weakening

<b>WARNING</b>	
	<p><b>Risk of unstable controller behavior</b></p> <p>The torque setpoint may not be higher than the maximum torque that can be made available from the motor at the current operating point.</p> <p><b>Possible consequences:</b></p> <ul style="list-style-type: none"> <li>• Output terminal overcurrent (diagnoses-no. 2334), drive coasts to stop</li> <li>• Drive coast to stop (induced voltage &gt; HV voltage = DC braking)</li> </ul> <p><b>Steps to prevent:</b></p> <ul style="list-style-type: none"> <li>• Calculate maximum nominal torque specification and limit online</li> </ul>



The maximum motor torque in the field weakening depends on the HV voltage. Change in the HV voltage, especially when accelerating must be taken into account by the user.

Below is an example, how to calculate the maximum allowed torque setpoint.

The maximum allowed torque setpoint [ $M_{\text{sollmax}}$ ] in dependence on the actual speed and the available motor power. The motor power is dependent on the HV voltage.



Locate on a test bench, the maximum motor power. Start the measurement series with a reduced motor power.

Determining field-weakening

The motor is in field weakening, if



The desired torque setpoint (in field weakening) must be :  $M_{\text{setpoint}} < M_{\text{sollmax}} < M_{\text{max}}$ .



## 7 Electrical connections

### 7.1 Interface overview and connections – inverter

Inverter:

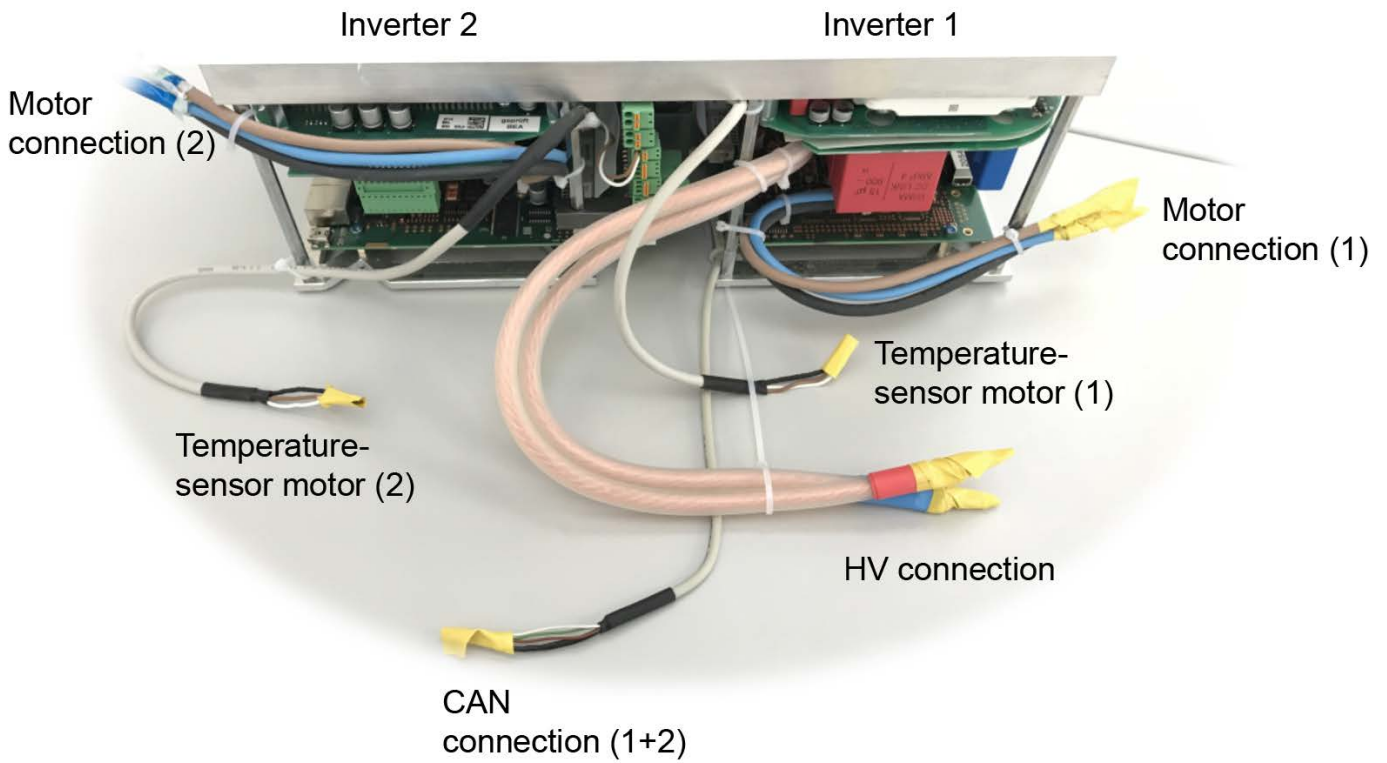

Controller card:

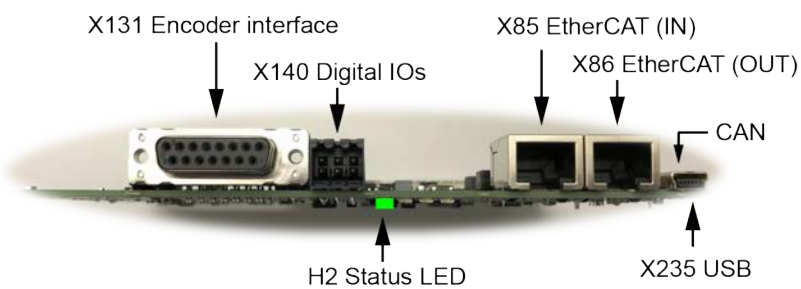

Supply and logic board:

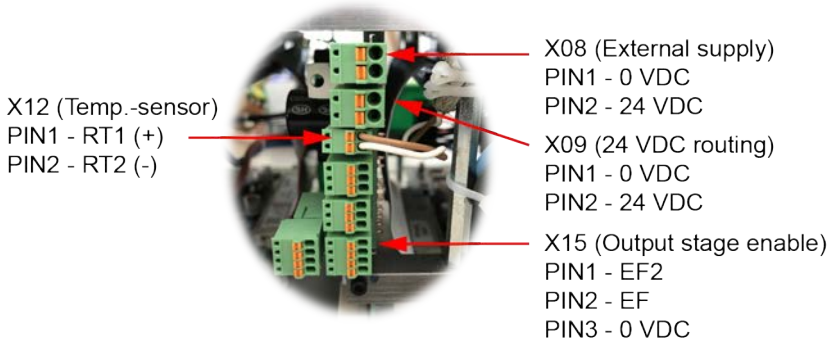

Transverse board terminal X12\_2

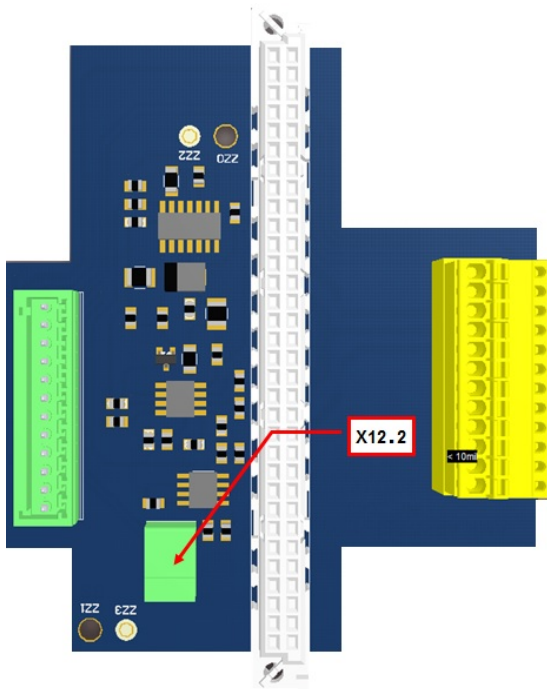

Overview of terminals

Interfaces	Number	Function
X08 / X09	2	Input for 24 VDC external supply (on-board supply) / 24 VDC routing <sup>1)</sup>
X12	4	Motor temperature monitoring
X13	2	Reserved
X14	2	Reserved
X15	2	Output stage enable <sup>1)</sup>
X16	2	Reserved
X85	4	Ethernet IN (EtherCAT) real time (connection to PC for AMK AIPEX PRO software (startup, diagnosis, and configuration) and ATF (firmware update))
X86	4	Reserved
X131	4	Motor encoder P encoder input, EnDat 2.1 (digital)
X140	4	Binary IOs (2 inputs, 1 output)

Interfaces	Number	Function
X235	4	USB (connection to PC for AMK AIPEX PRO software (startup, diagnosis, and configuration) and ATF (firmware update))

1) Common connection for I1 + I2

#### Overview of cable harness / open wire ends

Interfaces	Number	Function
HV+	2	Battery connection + <sup>1)</sup>
HV-	2	Battery connection - <sup>1)</sup>
U (brown)	4	Motor phase U
V (blue)	4	Motor phase V
W (black)	4	Motor phase W
T-mot	4	Motor temperature monitoring
CAN bus	2	CAN specification 2.0 A <sup>1)</sup>

1) Common connection for I1 + I2

#### Status LED H2

Class	Status	Note
Drive status	Green	System Ready (SBM)
	Green flashing	Drive under control (SBM and QRF)
	Orange flashing	Warning occurs during active controller enable
	Orange	Warning occurs during inactive controller enable / flash mode
	Red	Error with reaction depending on the error number

### 7.1.1 Stranded wires – CAN

#### Description:

Communication between the inverters and the higher-level controller takes place via a CAN bus. There are 2 variants for the configuration of the messages. [Siehe 'CAN Bus communication' auf Seite 61.](#)

#### Technical data:

- CAN specification 2.0 A

#### Design:

Design	Pins	Length	Type	Manufacturer	Description
14 mm <sup>2</sup> single conductors, screw-type	3 x 1	Approx. 30 cm	Shielded cable	Unitron	LiYCY (shielded)

#### Assignment:

Signal	Color mark	Description
CAN High	White	CAN data cable +
CAN Low	Brown	CAN data cable -
CAN GND	Green	GND
-	Black	Cable shielding

### 7.1.2 Stranded wires – HV+ and HV-

**⚠ DANGER**

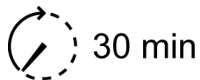
 	<p><b>Danger to life from electric shock!</b></p> <p>After switching off the HV circuit, the buffer capacitors for the DC bus can still have a charge and lead to a life-threatening DC voltage if they are not discharged via an external circuit.</p> <p><b>Steps to prevent:</b></p> <ul style="list-style-type: none"> <li>Prior to all work on the device, the HV power supply is to be separated from the main switch and secured against restarting.</li> <li>After switching off, expect a discharge time of at least 30 minutes.</li> <li>Measure the terminal voltage, e.g. in the HV DC bus between the HV+ and HV- terminals to ensure that the terminal is voltage-free.</li> <li>Caution: A voltage-free state is not signalled!</li> <li>Use external discharge circuit. <a href="#">Siehe 'Calculation example – discharging circuit' auf Seite 30.</a></li> </ul>
--	--

**Description:**

Supply voltage from the high-voltage battery for the DC link

HV +: connection to HV voltage +

HV -: connection to HV voltage -

**Technical data:**

- [Siehe 'Technical data – inverter' auf Seite 16.](#), HV voltage, DC link

**Design:**

Design	Pins	Length	Type	Manufacturer
10 mm <sup>2</sup> single conductors, screw-type	2 x 1	Approx. 30 cm	Silicone wire	Multi Contact

**Assignment:**

Signal	Color mark	Description
HV +	Red	HV voltage +
HV -	Blue	HV voltage -

**Connection:**

<b>Cable</b>	2 single conductors, apply copper shield
<b>Shield connection</b>	Apply shield on both sides: <ul style="list-style-type: none"> <li>Cold plate</li> <li>Connect the end of the shield on the battery side to the designated casing ground.</li> </ul>

### 7.1.3 Stranded wires – motor temperature sensor

The stranded wires are connected to terminal X12.

[Siehe '\[X12\] motor thermistor for temperature monitoring' auf Seite 48.](#)



**Design:**



Design	Pins	Length	Type	Manufacturer	Description
0.34 mm <sup>2</sup> single conductors, screw-type	2 x 1	Approx. 30 cm	Shielded cable	Unitron	LIYCY (shielded)

**Assignment:**

Signal	Color mark	Description
RT1 (+)	Brown	KTY + connection
RT2 (-)	White	KTY - connection
	Black	Cable shielding

**7.1.4 Stranded wires – motor phases U, V, W**

 <b>DANGER</b>	
	<p><b>Danger to life from touching electrical connections!</b></p> <p>The permanent magnets of the rotor induce dangerous voltage at the motor connections when the axis rotates, even when the motor is not electrically connected. If the motor is connected to an inverter, the induced DC voltage is linked to the terminals HV.</p> <p><b>Steps to prevent:</b></p> <ul style="list-style-type: none"> <li>• Make sure that the motor shaft does not rotate.</li> <li>• Make sure that shock-hazard protection is installed at the motor connections.</li> <li>• Make sure that the terminals HV are free of voltage.</li> </ul>

 <b>WARNING</b>	
	<p><b>Danger from uncontrolled movements of the motor shaft!</b></p> <p>An incorrect phase sequence with the motor connection can lead to uncontrolled movements of the motor shaft after being powered on.</p> <p><b>Steps to prevent:</b></p> <ul style="list-style-type: none"> <li>• Ensure that the motor phases are correctly connected.</li> </ul>

**Description:**

Connection of the U, V, W phases of the motor

**Technical data:**

- [Siehe 'Technical data – inverter' auf Seite 16.](#)

**Design:**

Design	Pins	Length	Type	Manufacturer	Description
6 mm <sup>2</sup> single conductors, soldered	3 x 1	Approx. 30 cm	Stranded wire	RADOX®	155 stranded wire

**Assignment:**

Signal	Color mark	Description
U	Brown	Phase U motor voltage
V	Blue	Phase V motor voltage
W	Black	Phase W motor voltage

**Connection:**

<b>Cable</b>	3 single conductors, shielded
<b>Shield connection</b>	Apply shield on both sides: <ul style="list-style-type: none"> <li>• Cold plate</li> <li>• Shield end applied on the motor side by AMK</li> </ul>



The cable shield must be continuous between the motor and inverter and applied on both sides. Unshielded cables can be shielded with a shielding braid. Allow transitions to overlap to a large extent.

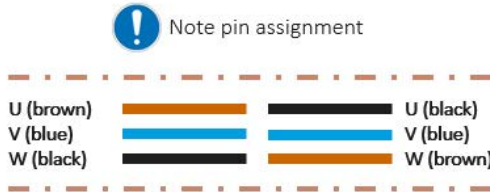
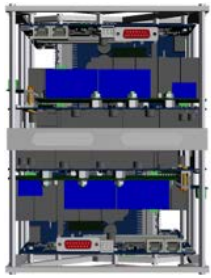

- 
- Continuous cable shield
  - Connect on both sides

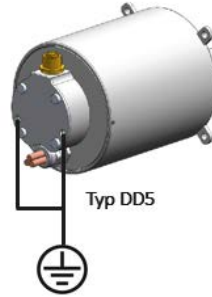

### 7.1.5 [X08] / [X09] 24 VDC supply voltage (on-board supply) and looping

#### NOTICE

<b>Material Damage!</b>	<b>Overload of the terminal and the internal circuit board!</b> The connected rating of the terminals X08, X09 is restricted. The terminals X08 or X09 are designed for a current of at most 8 A.
	<b>Steps to prevent:</b> <ul style="list-style-type: none"> <li>• A looping of the 24 VDC supply voltage is permitted for a total of 5 modules at the most.</li> <li>• If more than 5 devices are installed, each group of five needs to be supplied separately with 24 VDC.</li> </ul>

#### NOTICE

<b>Material Damage!</b>	<b>Material damage caused by incorrect handling!</b> Mechanical damage to terminals! Disconnected signal lines.
	<b>Steps to prevent:</b> <ul style="list-style-type: none"> <li>• The plug connectors are partially encoded. Do not push in with force.</li> <li>• Never pull on the cable, but rather on the connector casing.</li> <li>• For service purposes, use the control tap.</li> </ul>

**Description:**

For supplying the internal switched-mode power supply

X08: connection to 24 VDC supply voltage

X09: voltage looping





**Technical data:**

- 24 VDC ±15%
- Ripple max. 5% with integrated inrush current limitation
- The 0 V potential of the power supply is to be grounded at the central PE

**Design:**

Design	Pins	Type
Connector with tension spring connection	2	Single-row pin strip

**Assignment:**

[X08] / [X09]	Connection	Signal	Description
front view, device side X09 PIN 2  X09 PIN 1  X08 PIN 2  X08 PIN 1 	1	0 VDC	Connection 0 VDC logic supply
	2	24 VDC	Connection 24 VDC logic supply

**Connection:**

<b>Recommended cable type</b>	2-wire, unshielded
<b>Cable assembly</b>	Flexible cable or ferrule without plastic sleeve
<b>Min. / max. cross section</b>	0.25 mm <sup>2</sup> / 1.5 mm <sup>2</sup> AWG 24 / AWG 16
<b>Recommended cable cross section</b>	0.75 mm <sup>2</sup> AWG 18
<b>Cable stripping length</b>	9 mm
<b>Terminal</b>	FK-MCP 1.5/2-ST-3.80
<b>Note</b>	A failure of the 24 VDC supply that lasts > 10 ms will result in a fault

### 7.1.6 [X12] motor thermistor for temperature monitoring

NOTICE	
<b>Material Damage!</b>	<p><b>Material damage resulting from Overheating!</b></p> <p>AMK servo motors are provided with sensors for temperature monitoring. Motors without or with bypassed sensors for temperature can overheat and be destroyed.</p> <p><b>Steps to prevent:</b></p> <ul style="list-style-type: none"> <li>• Connect the sensors for temperature of the servo motor for temperature monitoring</li> <li>• Activate the I<sup>2</sup>t monitoring of the servo motor in ID32773 'Service bits' Bit 14.</li> </ul>
NOTICE	
<b>Material Damage!</b>	<p><b>Material damage caused by incorrect handling!</b></p> <p>Mechanical damage to terminals! Disconnected signal lines.</p> <p><b>Steps to prevent:</b></p> <ul style="list-style-type: none"> <li>• The plug connectors are partially encoded. Do not push in with force.</li> <li>• Never pull on the cable, but rather on the connector casing.</li> <li>• For service purposes, use the control tap.</li> </ul>

**Description:**

Connection for monitoring the temperature of a servo motor (can be configured via ID34166 'Temperature sensor motor').  
The X12 terminal is prewired with two strands. [Siehe 'Stranded wires – motor temperature sensor' auf Seite 44.](#)

**Assignment:**

Inverter W2: connection X12\_1

Inverter W1: connection X12\_2

**Technical data:**

- Temperature sensor (KTY)

**Design:**

Design	Pins
Connector with tension spring connection	2

**Assignment:**

[X12]	Connection	Signal	Description
front view, device side	1	RT1 (+)	Connection temperature sensor, take care of the polarity at KTY!
PIN 2  PIN 1	2	RT2 (-)	Connection temperature sensor, take care of the polarity at KTY!

**Connection:**

<b>Recommended cable type</b>	2-wire, shielded
<b>Cable assembly</b>	Flexible cable or ferrule without plastic sleeve
<b>Shield connection</b>	Apply on one side on module casing

<b>Min. / max. cross section</b>	0.25 mm <sup>2</sup> / 0.5 mm <sup>2</sup> AWG 24 / AWG 20
<b>Recommended cable cross section</b>	0.5 mm <sup>2</sup> AWG 20
<b>Cable stripping length</b>	8 mm
<b>Terminal</b>	FK-MC 0.5/2-ST-2.5



### 7.1.7 [X15] output stage enable (2-channel)

NOTICE	
<b>Material Damage!</b>	<p><b>Material damage caused by incorrect handling!</b></p> <p>Mechanical damage to terminals! Disconnected signal lines.</p> <p><b>Steps to prevent:</b></p> <ul style="list-style-type: none"> <li>• The plug connectors are partially encoded. Do not push in with force.</li> <li>• Never pull on the cable, but rather on the connector casing.</li> <li>• For service purposes, use the control tap.</li> </ul>

**Description:**

During normal operation, the inputs 'EF' and 'EF2' must be set simultaneously. This enables the power output stage.

An interruption to 'EF' and 'EF2' leads to the clock pulses for the power output stage being immediately and reliably blocked. If the controller enable (RF) is set, an error message is generated and the power output stage is blocked. [Siehe 'Drive behavior in the event of an error' auf Seite 83.](#)

**Technical data:**

- Electrically isolated via optocoupler
- Rated input voltage: +24 VDC ext.
- Pin 3 coding

**Design:**

Design	Pins
Connector with tension spring connection	4

**Assignment:**

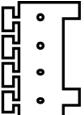
[X15]	Connection	Signal	Description
front view, device side PIN 4 PIN 3 PIN 2 PIN 1 	1	EF2	Power output stage enable EF2
	2,4	EF	Power output stage enable EF
	3	WEF	Reference potential 0 V ext. for the input current to EF / EF2

**Connection:**

<b>Recommended cable type</b>	4-wire, unshielded
<b>Cable assembly</b>	Flexible cable or ferrule without plastic sleeve
<b>Recommended cable cross section</b>	0.5 mm <sup>2</sup> AWG 20
<b>Cable stripping length</b>	8 mm
<b>Terminal</b>	FK-MC 0.5/4-ST-2.5

### 7.1.8 [X85] [X86]real-time Ethernet (EtherCAT)

**Description:**

The interface is designed as a real-time Ethernet interface and supports the EtherCAT SoE protocol (servo drive profile over EtherCAT (SoE) according to IEC 61800-7-300).

The EtherCAT interface enables the controller card to be connected to a PC and the installed AMKmotion AIPEX PRO software for the purposes of startup and diagnosis.

X85: IN (e.g. PC connection)

X86: OUT (forwarding next inverter)

**Technical data:**

- 100BASE-T 100 Mbit/s Ethernet standard
- Data frame and assignment of the RJ45 socket according to IEEE 802.3
- Maximum length 50 m (industrial environment)

**Design:**

Design	Pins	Type
RJ45	8	Socket

**Assignment:**

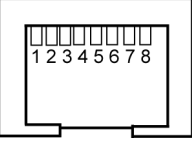
[X85] / [X86]	Pin	Signal	Description
front view, device side 	1	Tx+	Transmit data +
	2	Tx-	Transmit data -
	3	Rx+	Receive data +
	4	-	Reserved
	5	-	Reserved
	6	Rx-	Receive data -
	7	-	Reserved
	8	-	Reserved

**Connection:**

<b>Cable type</b>	CAT5e patch cable, shielded
<b>Min. / max. cross section</b>	0.32 mm <sup>2</sup> / AWG 22
<b>Shield connection</b>	On both sides
<b>Cable assembly</b>	RJ45 plug
<b>Note</b>	-

### 7.1.9 [X131] motor encoder

NOTICE	
<b>Material Damage!</b>	<p><b>Electronic components could be destroyed through static discharge!</b></p> <p>Therefore touching of the electrical connections (e. g. signal and power supply cable) must be avoided. Otherwise you can be damaged the components when touching by static discharge.</p> <p><b>Steps to prevent:</b></p> <ul style="list-style-type: none"> <li>• Avoid touching electrical connections and contacts.</li> <li>• During handling the electronic component discharge yourself by touching PE.</li> <li>• Pay attention to the ESD-notes (electrostatic discharge).</li> </ul>

#### Description

AMK type P motor encoders are installed in the RACING KIT. For further information: [Siehe 'Motor encoders' auf Seite 87.](#)

#### Technical data

- Input signals as per RS485 specification
- Encoder cable lengths:

Encoder description	ECI 1118
AMK encoder description	P
Max. encoder cable length [m]	100



The specified cable lengths are valid in conjunction with the specified voltage ranges and the cable cross sections recommended by AMK.

#### Design

Design	Pins	Type
D-SUB	15	Socket

#### Assignment

[X131]	Connection	P-encoder
front view, device side 	1	-
	2	-
	3	-
	4	-
	5	-
	6	-
	7	5 VDC <sup>1)</sup>
	8	GND
	9	-EN_DAT
	10	+EN_DAT
	11	-EN_CLK
	12	+EN_CLK
	13	5 VDC <sup>1)</sup>
	14	GND
	15	-

1) 5 VDC ±5 % max. 350 mA

Connection

P	
Cable	4 x 2 x 0.25 mm <sup>2</sup> twisted pair, + 4 x 0.5 mm <sup>2</sup> shielded
Shield connection	Apply on both sides
Cable assembly	D-SUB 15-pin plug, with metalized casing
Note	The cable shield is grounded on the motor side by means of the fitting in the plug casing.



**Recommended cable type:**

M12 plug, 8-pin, tightening torque 0.4 Nm  
 Minimum cross section 0.25 mm<sup>2</sup>, shielded

The connection cable with angled plug and data cables is available for order from:  
 Phoenix Contact, description: SAC-8P-M12MR/5,0-PUR SH  
 (not part of the AMKmotion RACING KIT)

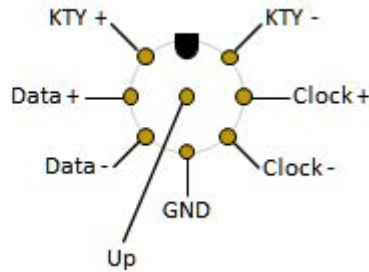

Controller input circuit

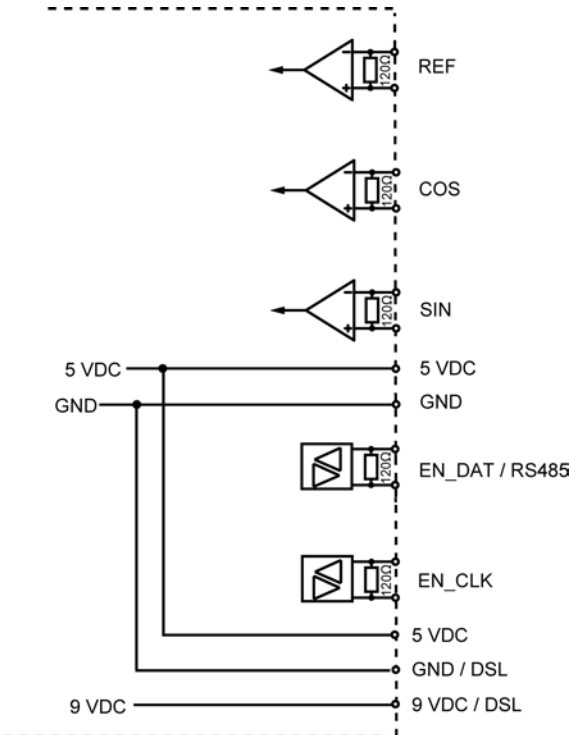

Encoder signal evaluation

In ID32953 'Encoder type' is defined how to evaluate the incoming encoder signals.

### 7.1.10 [X140] Digital inputs and outputs

NOTICE	
<b>Material Damage!</b>	<p><b>Electronic components could be destroyed through static discharge!</b></p> <p>Therefore touching of the electrical connections (e. g. signal and power supply cable) must be avoided. Otherwise you can be damaged the components when touching by static discharge.</p> <p><b>Steps to prevent:</b></p> <ul style="list-style-type: none"> <li>• Avoid touching electrical connections and contacts.</li> <li>• During handling the electronic component discharge yourself by touching PE.</li> <li>• Pay attention to the ESD-notes (electrostatic discharge).</li> </ul>

**Description**

At terminal X140, the controller card has 2 digital inputs and 1 digital output.

**Technical data**

- Norm IEC 61131-2 type 3 digital inputs:  
 Rated input voltage 0-30 VDC, maximal input current at 30 VDC = 15 mA  
 Level 0-5 VDC: low, 11-30 VDC: high  
 Electrically delay of  $T_{on} = 3-8 \mu s$ ,  $T_{off} = 48-57 \mu s$
- Norm IEC 61131-2 digital outputs:  
 Rated output voltage 24 VDC, rated output current maximal 0.5 A, short-circuit safe, electrically isolated, electrically delay of  $T_{on} 8-20 \mu s$ ,  $T_{off} = 50-55 \mu s$  at 200 mA load

**Design**

Design	Pins	Type
Connector with tension spring connection	6	2-row pin strip

**Assignment:**

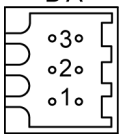
[X140]	Connection	Signal	Description
front view, device side B A 	1A	DO3	Digital output 3, 24 VDC, 2.5 A, potential separated, permanently short-circuit safe.
	1B	BGND	Reference potential 0 V for supply of the binary inputs and outputs
	2A	BGND	Reference potential 0 V for supply of the binary inputs and outputs
	2B	DI2	Digital input 2, 24 VDC $\pm 15 \%$ , max. 10 mA, potential separated, e.g. probe input, cam
	3A	BVCC	Supply of the binary outputs 24 VDC $\pm 15 \%$
	3B	DI1	Digital input 1, 24 VDC $\pm 15 \%$ , max. 10 mA, potential separated, e.g. RF

**FSE function – binary input DI1**

DI1 is similar to the terminal designation X15 (ignition key) in the automotive sector.

DI1 = 1 : controller enable RF possible

DI1 = 0 : controller enable RF blocked

**FSE function – binary input DI2**

Activating the predefined torque limits requires the DI2 hardware input to be set.

DI2 = 1 : torque limits active

DI2 = 0 : torque limits deactivated, motor without torque

**FSE function – binary output DO3**

Aerating active, due to overload or battery protection

DO3 = 0 : The torque limits are not affected

DO3 = 1 : The torque limits are reduced by FSE firmware



Parameterisation of IOs:  
 Siehe 'IO Parameter' auf Seite 37.

**Connection**

<b>Cable</b>	6 x 0.8 mm <sup>2</sup> (max.) / AWG 18, shielded
<b>Shield connection</b>	Apply on one side on module casing
<b>Cable assembly</b>	Weidmüller socket connector, 6-pin AMK part no. 202700

**Circuit**

Binary Outputs

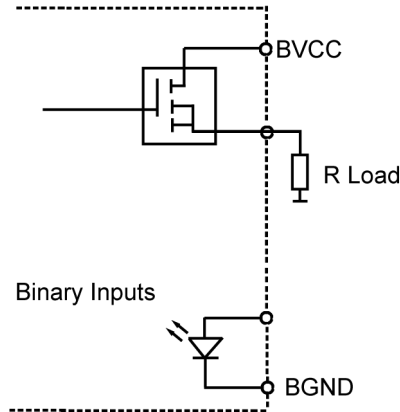

**7.1.11 [X235] USB**

**Description:**

The inverters have a mini USB interface, which can be used to connect them to a PC and the AIPEX PRO software for the purposes of startup and diagnosis.

**Technical data:**

USB V1.1 slave

**Design:**

Design	Pins	Type
USB V1.1 type A as per mini USB type B	5	Port

**Assignment:**

[X235]	Connection	Signal	Description
Front view, device side 	1	5 VDC input	External 5 VDC supply from USB master, power consumption max. 50 mA
	2	D-	Data -
	3	D+	Data +
	4	5 VDC	Reserved for AMK
	5	GND	Ground

**Connection:**

<b>Cable type</b>	Data+ and data- twisted pair, shielded
<b>Min. / max. cross section</b>	0.08 mm <sup>2</sup> / AWG 28
<b>Shield connection</b>	Apply on both sides
<b>Cable assembly</b>	Assembled cables
<b>Note</b>	Max. length of 3 m permitted for USB cables. Larger cable lengths are possible with an active USB repeater.

## 7.2 Interface overview and connections – motor

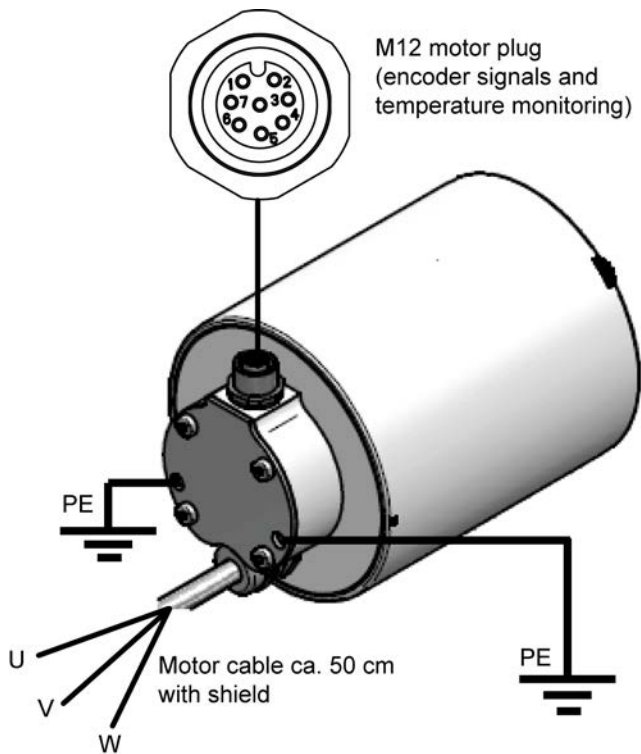

### Coding motor phases

#### DD5

- U - Black
- V - Blue
- W - Brown

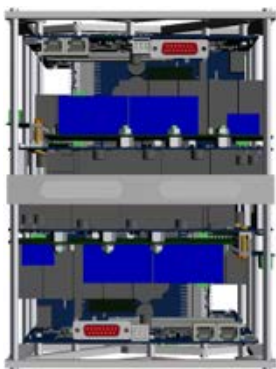

Note pin assignment



- Continuous cable shield
- Connect on both sides

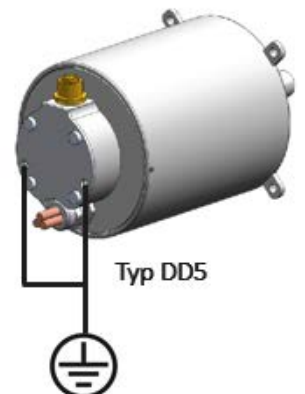

## 7.2.1 M12 motor connector (encoder signals and temperature monitoring)

NOTICE	
<b>Material Damage!</b>	<p><b>Electronic components could be destroyed through static discharge!</b></p> <p>Therefore touching of the electrical connections (e. g. signal and power supply cable) must be avoided. Otherwise you can be damaged the components when touching by static discharge.</p> <p><b>Steps to prevent:</b></p> <ul style="list-style-type: none"> <li>• Avoid touching electrical connections and contacts.</li> <li>• During handling the electronic component discharge yourself by touching PE.</li> <li>• Pay attention to the ESD-notes (electrostatic discharge).</li> </ul>

### Description

Connection socket for encoder signals and temperature monitoring

### Technical data

AMK type P motor encoder, EnDat 2.2 light (digital) <sup>1)</sup>

KTY temperature sensor

- 1) EnDat 2.2 light means, that the encoder supports EnDat 2.2, which is used only with the commands of EnDat 2.1 from the AMK controller.

### Design

Design	Pins	Type
M12 socket	8	-

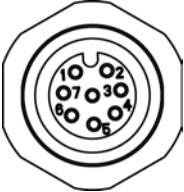
	Connection	Signal	Terminal on inverter	Name of connection on inverter	Description
	1	KTY-	X12 (unconnected cable end present)	RT2 (-)	Temperature sensor connection, observe polarity for KTY!
	2	KTY+		RT1 (+)	Temperature sensor connection, observe polarity for KTY!
	3	Data+	X131	+EN_DAT	Digital data signal
	4	Data-		-EN_DAT	Digital data signal (inverted)
	5	GND		GND	Ground
	6	Clock-		-EN_CLK	Clock signal
	7	Clock+		+EN_CLK	Clock signal inverted
	8	Up	5 VDC ±5% Max. 350 mA	Voltage supply	



**Connection**



**Recommended cable type:**  
 M12 plug, 8-pin, tightening torque 0.4 Nm  
 Minimum cross section 0.25 mm<sup>2</sup>, shielded

The connection cable with angled plug and data cables is available for order from:  
 Phoenix Contact, description: SAC-8P-M12MR/5,0-PUR SH  
 (not part of the AMKmotion RACING KIT)

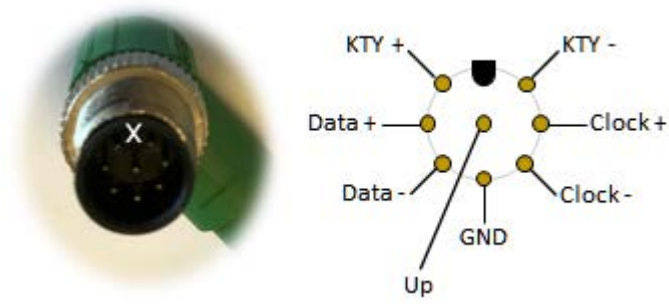

Connect shield across the surface and apply to connector X131.

**7.2.2 Motor cable**

⚠ DANGER	
	<p><b>Danger to life from touching electrical connections!</b></p> <p>The permanent magnets of the rotor induce dangerous voltage at the motor connections when the axis rotates, even when the motor is not electrically connected. If the motor is connected to an inverter, the induced DC voltage is linked to the terminals HV.</p> <p><b>Steps to prevent:</b></p> <ul style="list-style-type: none"> <li>Make sure that the motor shaft does not rotate.</li> <li>Make sure that shock-hazard protection is installed at the motor connections.</li> <li>Make sure that the terminals HV are free of voltage.</li> </ul>

**Description:**

Connection of the U, V, W phases of the motor

**Technical data:**

- [Siehe 'Technical data – inverter' auf Seite 16.](#)

**Design:**

Design	Pins	Length	Type
4 mm <sup>2</sup> single conductor, shielded	3 x 1	Approx. 50 cm	Stranded wires, shielded

**Assignment motor type DD5:**

Signal	Color mark	Description
U	Black	Phase U motor voltage
V	Blue	Phase V motor voltage
W	Brown	Phase W motor voltage



The cable shield must be continuous between the motor and inverter and applied on both sides. Unshielded cables can be shielded with a shielding braid. Allow transitions to overlap to a large extent.

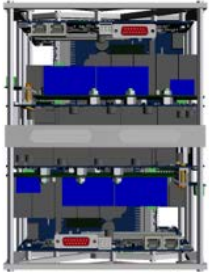

 Note pin assignment



- Continuous cable shield
- Connect on both sides

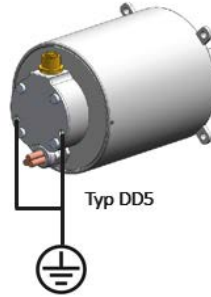

### 7.2.3 PE connection

#### DANGER



#### Danger to life from electric shock!

In the event of an interruption to the PE connection, hazardous voltages may be present on the casing.

#### Preventive measures:

- The PE connection must be designed with a cable cross section of at least 10 mm<sup>2</sup>.
- The PE connection is screwed into the motor casing with a ring cable lug and an M5 screw.

#### Connection:

<b>Recommended cable type</b>	1-wire at least 10 mm <sup>2</sup> or ground strap
<b>Cable assembly</b>	Ring cable lug
<b>Connection</b>	M5 x 12

## 8 Functionality

### 8.1 CAN bus (R25)

#### 8.1.1 Wiring CAN BUS lines

It is intended that one inverter pair ( I1 + I2) will be operated at one common CAN.

A fieldbus cable approx. 30 cm in length is soldered in each inverter pair ( I1 + I2). A 120 ohm bus terminator is integrated in the I2 controller card.

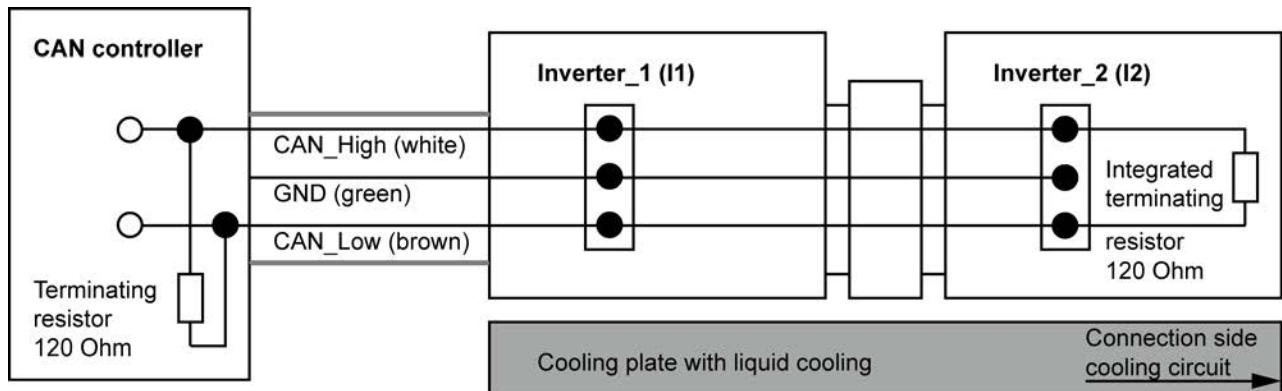

#### Variant with two CAN wires



**Variant with one CAN**

With this variant, the CAN terminating resistors R314 and R316 must be desoldered and the CAN cable extended.



AMKmotion does not assume any liability for damages that may occur due to soldering and unsoldering of the components.

**CAN1**  
CONTROLLER

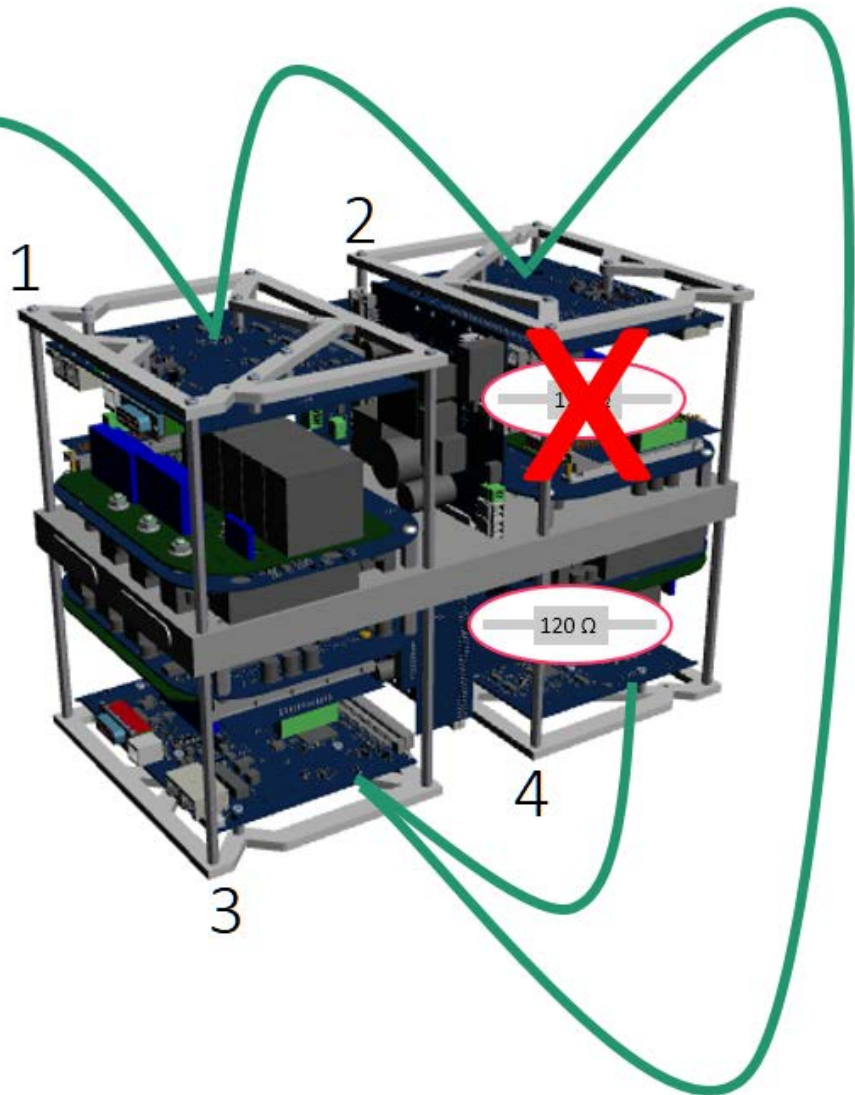

Pin assignment CAN line and arrangement of CAN terminating resistors R314 and R316

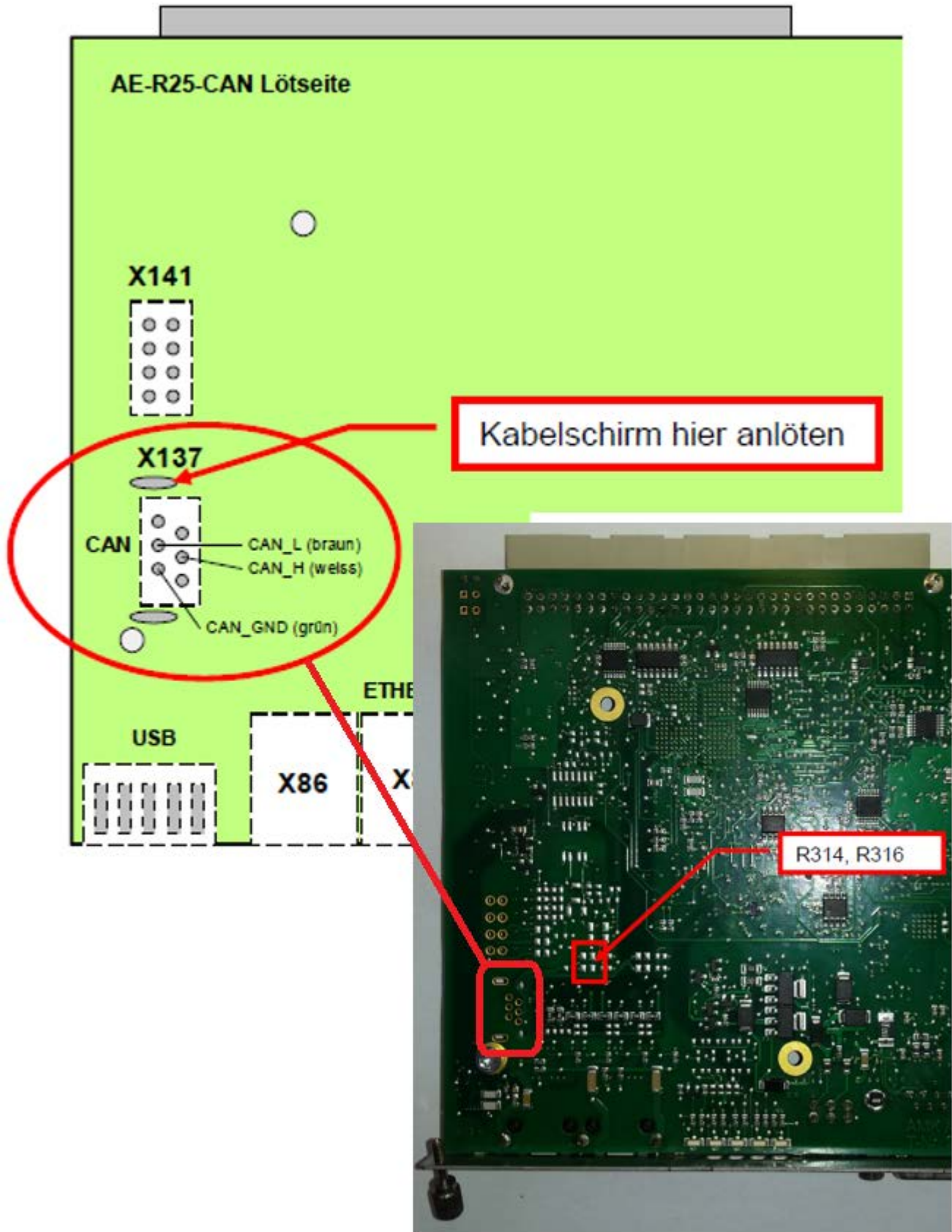

### 8.1.2 CAN Bus communication

Communication between the inverters and the higher-level controller takes place via a CAN bus 2.0 A (high-speed). CAN 2.0 A bus supports the 11-bit identifier format ('base frame format'). The 29 bit identifier format ('Extended frame format' called CAN 2.0 B) is not supported.

There are 2 variants available for data exchange:

**Mode 'Fixed CAN message configuration'**

Clearly defined CAN messages are implemented for exchanging data.

**Mode 'Free CAN message configuration'**

The data exchange between inverter and CAN controller can be configured by the user.

Configurable signals:

- Process data from the list of SERCOS parameters: [Siehe 'SERCOS parameter' auf Seite 77.](#)
- Process data from the list of special signals: [Siehe 'Special Signals' auf Seite 75.](#)



The operation mode 'Torque control' can only be implemented with the mode 'Free CAN message configuration'.

**8.1.2.1 Mode 'Fixed CAN message configuration'**

The data telegrams are each 8 bytes long and are transmitted in Intel format. The telegram failure monitoring is activated with the first received data message.

Clearly defined CAN messages are implemented for exchanging data.

Name	Direction	Meaning
AMK Actual Values 1	Inverter → CAN controller	Contains the status word and actual values
AMK Actual Values 2	Inverter → CAN controller	Contains actual values
AMK Setpoints 1	CAN controller → inverter	Contains the status word and setpoints

The 'Fixed CAN message configuration' is configured with ID34091 'User list 3'.

Configuration	Value type	Meaning	
Node address and selection mode	UNS16 (2 Byte)	<b>'High Byte'</b>	<b>'Low Byte'</b>
		freely selectable (node address)	04 (fixed configuration)
Transmission rate in kBit/s	UNS16 (2 Byte)	Transmission rate 0 = default value 500 kBit/s	
Output rate in ms	UNS16 (2 Byte)	Output rate 0 = default value 5 ms	

**Controller configuration**

The CAN identifier with which the inverter sends and receives data consists of the base address + node address.

Name	Base address	Node address	CAN Identifier
AMK Actual Values 1	0x282	x	0x282 + x
AMK Actual Values 2	0x284	x	0x284 + x
AMK Setpoints 1	0x183	x	0x183 + x



Example:

1 CAN Bus with the node addresses 1, 2, 5, 6.

	Node address	ID34091 'User list 3' List item 2	CAN Identifier	Name
Inverter 1	1	0x0104	0x283 0x285 0x184	AMK Actual Values 1 AMK Actual Values 2 AMK Setpoints 1
Inverter 2	2	0x0204	0x284 0x286 0x185	AMK Actual Values 1 AMK Actual Values 2 AMK Setpoints 1
Inverter 3	5	0x0504	0x287 0x289 0x188	AMK Actual Values 1 AMK Actual Values 2 AMK Setpoints 1
Inverter 4	6	0x0604	0x288 0x290 0x189	AMK Actual Values 1 AMK Actual Values 2 AMK Setpoints 1



The node addresses must be selected in such a way, that no identical CAN identifiers can arise in the same CAN bus system several times.

### Description of the data telegrams

The following data telegrams are available for exchanging data between the inverter and CAN controller:

Base address	Name	Direction	Meaning
0x282	AMK Actual Values 1	Inverter → CAN controller	Contains the status word and actual values
0x284	AMK Actual Values 2	Inverter → CAN controller	Contains actual values
0x183	AMK Setpoints 1	CAN controller → inverter	Contains the status word and setpoints

Content of the 'AMK Actual Values 1' data telegram:

Name	Offset	Length in bits	Value type	Unit	Meaning
AMK_Status	0	16	Unsigned	-	Status word See the table below: Content of the 'AMK_Status' status word
AMK_ActualVelocity	16	16	Signed	rpm	Actual speed value
AMK_TorqueCurrent	32	16	Signed	-	Raw data for calculating 'actual torque current' Iq <a href="#">Siehe 'Units' auf Seite 83.</a>
AMK_MagnetizingCurrent	48	16	Signed	-	Raw data for calculating 'actual magnetizing current' Id (field weakening current) <a href="#">Siehe 'Units' auf Seite 83.</a>

Content of the 'AMK\_Status' status word

The system status and the command acknowledgments are displayed via the status word.

Name	Offset	Length in bits	Meaning
AMK_bReserve	0	8	Reserved
AMK_bSystemReady	8	1	System ready (SBM)
AMK_bError	9	1	Error
AMK_bWarn	10	1	Warning
AMK_bQuitDcOn	11	1	HV activation acknowledgment
AMK_bDcOn	12	1	HV activation level
AMK_bQuitInverterOn	13	1	Controller enable acknowledgment
AMK_bInverterOn	14	1	Controller enable level
AMK_bDerating	15	1	Derating (torque limitation active)

Content of the 'AMK Actual Values 2' data telegram:

Name	Offset	Length in bits	Value type	Unit	Meaning
AMK_TempMotor	0	16	Signed	0.1 °C	Motor temperature
AMK_TempInverter	16	16	Signed	0.1 °C	Cold plate temperature
AMK_ErrorInfo	32	16	Unsigned	-	Diagnostic number
AMK_TempIGBT	48	16	Signed	0.1 °C	IGBT temperature

Content of the 'AMK Setpoints 1' data telegram:

Name	Offset	Length in bits	Value type	Unit	Meaning
AMK_Control	0	16	Unsigned	-	Control word See the table below: Content of the 'AMK_Control' control word
AMK_TargetVelocity	16	16	Signed	rpm	Speed setpoint
AMK_TorqueLimitPositiv	32	16	Signed	0.1% M <sub>N</sub>	Positive torque limit (subject to nominal torque)
AMK_TorqueLimitNegativ	48	16	Signed	0.1% M <sub>N</sub>	Negative torque limit (subject to nominal torque)

Content of the 'AMK\_Control' control word

The control word can be used to trigger the following commands in the inverter:

Name	Offset	Length in bits	Meaning
AMK_bReserve	0	8	Reserved
AMK_bInverterOn	8	1	Controller enable
AMK_bDcOn	9	1	HV activation
AMK_bEnable	10	1	Driver enable
AMK_bErrorReset	11	1	Remove error*
AMK_bReserve	12	4	Reserved

\*Setpoints must have the value 0, as otherwise the 'Remove error' command will not be executed.

**Telegram failure monitoring:**



Telegram failure monitoring:

The telegram failure monitoring is activated with the first received data message. Following the data telegrams must be transmitted cyclically.

The telegram failure monitoring function responds if the inverter has not received a telegram from the CAN controller for more than 50 ms.

In this case, the inverter generates an error message and the motor coasts down (setpoint 0 %M<sub>N</sub>).

**8.1.2.1.1 Parametrization 'Fixed CAN message configuration'**

For parameterizing the 'Fixed CAN message configuration' ID34091 'User list 3' is used.



ID34091 'User list 3' is a 'System-internal parameter'. The parameter must be enabled for configuration.

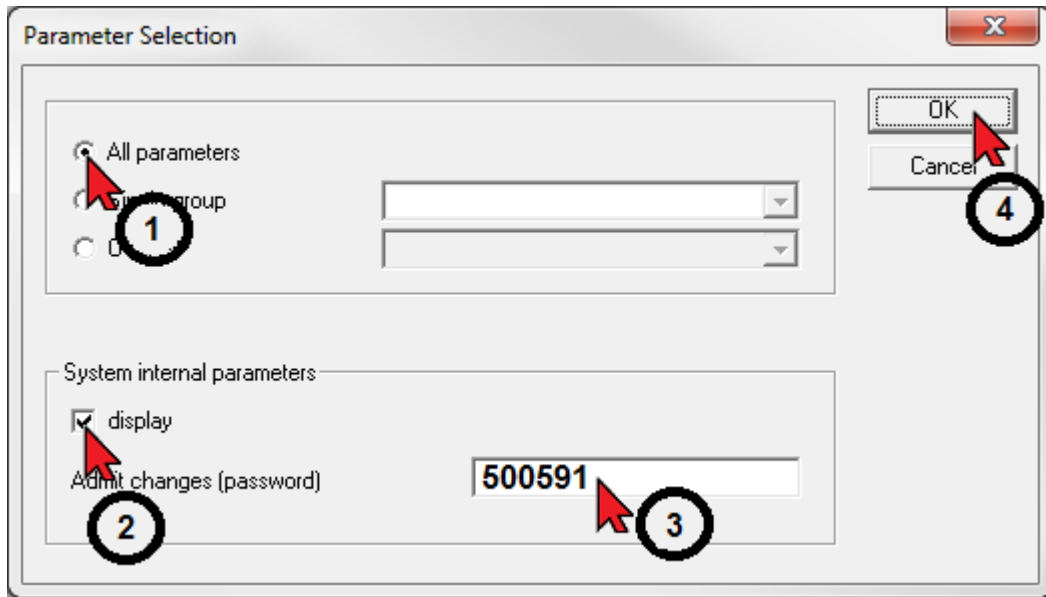

With the search function, you can jump directly to the entered parameter.

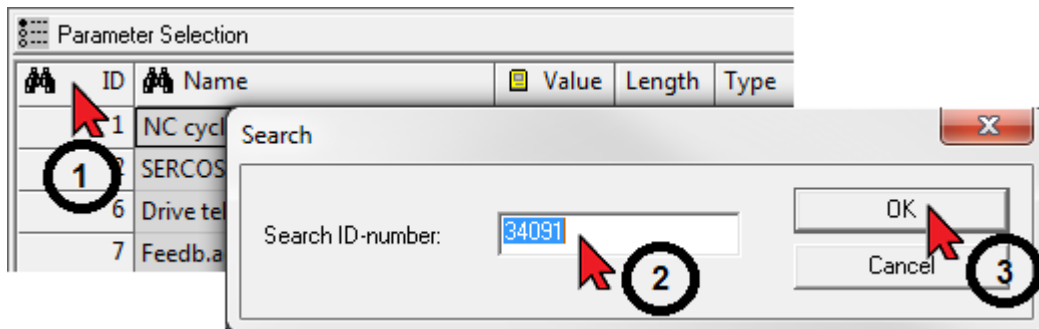

Enter the list length. The list length is application-specific and must be adapted to the CAN configuration.  
(Click on the left mouse button, wait shortly and click again)

Recommended starting value: 1

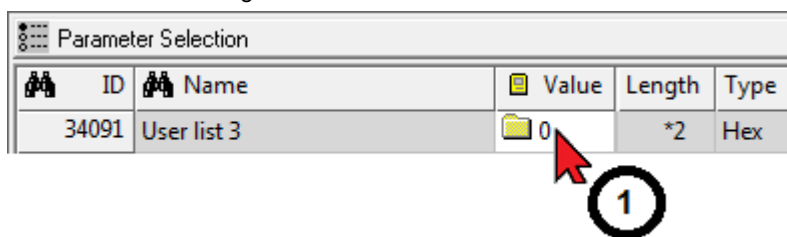

Example:

Configuration with default values					Configuration with application-specific values				
ID	Name	Wert	Länge	Typ	ID	Name	Value	Length	Type
34091	User list 3	3	*2	Hex	34091	User list 3	3	*2	Hex
34091-1	[maximum]	[1024]			34091-1	[maximum]	[1024]		
34091-2	Node address and mode	0104	2	Hex	34091-2	Node address and mode	0104	2	Hex
34091-3	Transmission rate in kBit/s	0000	2	Hex	34091-3	Transmission rate in kBit/s	1000	2	Dec
34091-4	Output rate in ms	0000	2	Hex	34091-4	Output rate in ms	1	2	Dec
(High Byte) Node address = 0x01 (Low Byte) Fixed configuration = 0x04 Transmission rate kBit/s = 0 = Default value 500 kBit/s Output rate in ms = 0 = Default value 5 ms					(High Byte) Node address = 0x01 (Low Byte) Fixed configuration = 0x04 Transmission rate in kBit/s = 1000 Output rate in ms = 1				



The node addresses must be selected in such a way, that no identical CAN identifiers can arise in the same CAN bus system several times.

### 8.1.2.2 Mode 'Free CAN message configuration'

In 'Free CAN message configuration' mode, the data exchange between inverter and CAN control can be freely configured by the user.

When configuring, note that the maximum data length of 8 bytes is maintained and the transmission rate is sufficient for the selected transmission cycles.

Characteristics:

- CAN 2.0 A bus supports the 11-bit identifier format ('base frame format')
- Any CAN identifier
- Transmission in Intel format
- Up to 10 send messages which can contain up to 10 signals
- Up to 10 receive messages each containing up to 10 signals
- Transmission of SONDER signals: [Siehe 'Special Signals' auf Seite 75.](#)
- Transmission of SERCOS parameters: [Siehe 'SERCOS parameter' auf Seite 77.](#)
- Limitation data range of a signal
- Cyclic transmission, variable output rates in 1 ms steps
- Event-controlled transmission, variable delay time in 1 ms steps
- Variable transfer rate
- Inverted control signal for the plausibility check of setpoints and actual values
- Telegram failure monitoring
- Message counter
- Checksum

The message configuration is configured with ID34091 'User list 3' application specific.

Structure ID34091 'User list 3':

Selection mode

```

Total of send messages
(max. 10 send messages)
    Head send message 1
        Total of signals
        (max. 10 signals)
            Signal 1
            Signal 2
            ...
        Head send message 2
        ...
Total of receive messages
(max. 10 receive messages)
    Head receive message 1
        Total of signals
        (max. 10 signals)
            Signal 1
            Signal 2
            ...
        Head receive message 2
        ...
    
```

Transmission rate

The end

Detailed structure ID34091 'User list 3'

Parameter Selection				
ID	Name	Value	Length	Type
34091	User list 3	56	*2	Hex
34091-1	[maximum]	[1024]		
34091-2	Selection mode	01	1	Hex
34091-3	Total of send messages	2	1	Dec
34091-4	CAN Identifier send messages 1	0283	2	Hex
34091-5	Zyclus in ms	5	2	Dec



The configuration values must be entered ascending in the list elements of ID34091 'User list 3'. No values may be omitted.

The default length of a list item is 2 bytes. For 1 byte values, the length must be adjusted manually.

Configuration	Data value	Meaning							
Selection mode	UNS08 (1 byte)	The 'Free CAN message configuration' is activated with the value 0x01.							
<b>Send messages</b>	<b>Data value</b>	<b>Meaning</b>							
	UNS08 (1 byte)	Total of send messages (max. 10 send messages)							
Head send message 1	UNS16 (2 byte)	CAN Identifier send messages 1							
	UNS16 (2 byte)	Cycle <ul style="list-style-type: none"> <li>Cyclic transmission Cycle time of the message in ms</li> <li>Event-controlled transmission Delay time for event-driven messages in ms</li> </ul> See 'Send message attribute'							
	UNS08 (1 byte)	Data length The data length is the sum of the configured signals. Possible data length 1 .. 8 bytes.  Example: Signal 1: 1 byte Signal 2: 1 byte Signal 3: 2 byte Data length message 1 = 4 byte  Specifying the exact data length reduces the bus load.							
	UNS08 (1 byte)	Attribute send message Setting of message properties <table border="1"> <thead> <tr> <th>Bit</th> <th>Value</th> <th>Meaning</th> </tr> </thead> <tbody> <tr> <td rowspan="2">0</td> <td>0</td> <td>Message is sent cyclically Enter the cycle time, see 'Cycle'</td> </tr> <tr> <td>1</td> <td>Event driven Message is sent when one of its signals is changed, but at the earliest after the delay set in 'Cycle'.</td> </tr> </tbody> </table>	Bit	Value	Meaning	0	0	Message is sent cyclically Enter the cycle time, see 'Cycle'	1
Bit	Value	Meaning							
0	0	Message is sent cyclically Enter the cycle time, see 'Cycle'							
	1	Event driven Message is sent when one of its signals is changed, but at the earliest after the delay set in 'Cycle'.							

Send messages	Data value	Meaning
	UNS08 (1 byte)	<p>Total of signals Up to 10 signals with a total data length of 8 bytes in a send message.</p> <p> A send message is limited to 8 bytes.</p> <p>Example: Signal 1: 2 byte Signal 2: 2 byte Signal 3: 2 byte Signal 4: 1 byte Signal 5: 1 byte Data length Send message = 8 byte</p> <p>Total of signals = 5</p>
Configuration signal 1 of the send message 1	UNS08 (1 byte)	<p>Signal type The signal type determines if the following signal ('Index') is a 'SERCOS parameter' or 'Special signal'.</p> <p>0 SERCOS parameter <a href="#">Siehe 'SERCOS parameter' auf Seite 77.</a> Requirement: 'Signal typ' = 0 (SERCOS)</p> <p>2 Special Signal <a href="#">Siehe 'Special Signals' auf Seite 75.</a> Requirement: 'Signal typ' = 2 (Special)</p>
	UNS08 (1 byte)	<p>Reserved: Only value 0 is allowed.</p>
	UNS16 (2 byte)	<p>Index Signal number 1 of the send message 1</p> <p>SERCOS parameter <a href="#">Siehe 'SERCOS parameter' auf Seite 77.</a> Requirement: 'Signal typ' = 0 (SERCOS)</p> <p>Special signal <a href="#">Siehe 'Special Signals' auf Seite 75.</a> Requirement: 'Signal typ' = 2 (Special)</p>
	UNS08 (1 byte)	<p>Length in bits The data length of a signal can be limited by specifying 'Length in bits'.</p> <p>Example: Signal data length bbbb aaaa (1 byte). User data bit 0..3 'Length in bits' = 4 Transmitted value: aaaa</p> <p>With 'Attribute send signal bit 2' , you can set if the higher-order bits are omitted or the signal is limited to the maximum displayable value.</p>

Send messages	Data value	Meaning																		
	UNS08 (1 byte)	<p>Shift in bits<sup>2)</sup></p> <p>The entered value is used to specify the start bit of the signal in the message. (0..63 bit)</p> <p>Example: 3 Signals in a send message Signal 1; size 1 byte: shift in bit = 0 Signal 2; size 2 byte: shift in bit = 8 Signal 3; size 1 byte: shift in bit = 24</p>																		
	UNS08 (1 byte)	<p>Attribute send signal Setting of the signal characteristics</p> <table border="1"> <thead> <tr> <th>Bit</th> <th>Value</th> <th>Meaning</th> </tr> </thead> <tbody> <tr> <td rowspan="2">0<sup>1)</sup></td> <td>0</td> <td>Do not send inverted control signal</td> </tr> <tr> <td>1</td> <td> <p>The signal is followed by an inverted control signal of the same bit length.</p> <p>The receiver can thus additionally check the signal. For example, you can do a plausibility check of the set and actual values.</p> <div style="display: flex; align-items: center;"> <p>A maximum of 1 inverted control signal can be transmitted per send message. This length must be taken into account at the start bits 'Shift in bits' and the 'Data length'.</p> </div> </td> </tr> <tr> <td rowspan="2">1</td> <td>0</td> <td>The signal is unsigned. (For example, status word)</td> </tr> <tr> <td>1</td> <td>The signal is signed. (For example, torque current actual value)</td> </tr> <tr> <td rowspan="2">2</td> <td>0</td> <td>The signal contains the low-order bits of the variable entered in 'Length in bits'. Higher-value bits are lost. Example: 1 byte signal; 'Length in bits' = 4; signal value: 0001 0011; transmission: 0011</td> </tr> <tr> <td>1</td> <td>The signal is limited to the maximum value who is possible with the entered 'Length in bits'. Example: 1 byte signal; 'Length in bits' = 4; signal value: 0001 0011; transmission: 1111</td> </tr> </tbody> </table>	Bit	Value	Meaning	0 <sup>1)</sup>	0	Do not send inverted control signal	1	<p>The signal is followed by an inverted control signal of the same bit length.</p> <p>The receiver can thus additionally check the signal. For example, you can do a plausibility check of the set and actual values.</p> <div style="display: flex; align-items: center;"> <p>A maximum of 1 inverted control signal can be transmitted per send message. This length must be taken into account at the start bits 'Shift in bits' and the 'Data length'.</p> </div>	1	0	The signal is unsigned. (For example, status word)	1	The signal is signed. (For example, torque current actual value)	2	0	The signal contains the low-order bits of the variable entered in 'Length in bits'. Higher-value bits are lost. Example: 1 byte signal; 'Length in bits' = 4; signal value: 0001 0011; transmission: 0011	1	The signal is limited to the maximum value who is possible with the entered 'Length in bits'. Example: 1 byte signal; 'Length in bits' = 4; signal value: 0001 0011; transmission: 1111
Bit	Value	Meaning																		
0 <sup>1)</sup>	0	Do not send inverted control signal																		
	1	<p>The signal is followed by an inverted control signal of the same bit length.</p> <p>The receiver can thus additionally check the signal. For example, you can do a plausibility check of the set and actual values.</p> <div style="display: flex; align-items: center;"> <p>A maximum of 1 inverted control signal can be transmitted per send message. This length must be taken into account at the start bits 'Shift in bits' and the 'Data length'.</p> </div>																		
1	0	The signal is unsigned. (For example, status word)																		
	1	The signal is signed. (For example, torque current actual value)																		
2	0	The signal contains the low-order bits of the variable entered in 'Length in bits'. Higher-value bits are lost. Example: 1 byte signal; 'Length in bits' = 4; signal value: 0001 0011; transmission: 0011																		
	1	The signal is limited to the maximum value who is possible with the entered 'Length in bits'. Example: 1 byte signal; 'Length in bits' = 4; signal value: 0001 0011; transmission: 1111																		
Configuration signal 2 of the send message 1		The configuration signal 2 of the transmission message 1 'and the following signals corresponds to that of the signal 1.																		
Receive message	Data value	Meaning																		
	UNS08 (1 byte)	Total of receive messages (max. 10 receive messages)																		

Receive message	Data value	Meaning
Head receive message 1	UNS16 (2 byte)	CAN Identifier receive message 1
	UNS16 (2 byte)	Telegram failure monitoring <sup>3)</sup> Error message in case of failure of the message, after the specified time in ms; 0 = no monitoring
	UNS08 (1 byte)	Data length The data length is the sum of the configured signals. Possible data length 1 .. 8 bytes.  Example: Signal 1: 1 byte Signal 2: 1 byte Signal 3: 2 byte Data length message 1 = 4 byte  Specifying the exact data length reduces the bus load.
	UNS08 (1 byte)	Attribute receive message Only value 0 is allowed.
	UNS08 (1 byte)	Total of signals Up to 10 signals with a total data length of 8 bytes in a receive message.   A receive message is limited to 8 bytes.  Example: Signal 1: 2 byte Signal 2: 2 byte Signal 3: 2 byte Signal 4: 1 byte Signal 5: 1 byte 'Data length' receive message = 8 byte  'Total of signals' = 5
Configuration signal 1 of the receive message	UNS08 (1 byte)	Signal type The signal type determines if the following signal ('Index') is a 'SERCOS parameter' or 'Special signal'.  0 SERCOS parameter <a href="#">Siehe 'SERCOS parameter' auf Seite 77.</a> Requirement: 'Signal typ' = 0 (SERCOS)  2 Special Signal <a href="#">Siehe 'Special Signals' auf Seite 75.</a> Requirement: 'Signal typ' = 2 (Special)
	UNS08 (1 byte)	Reserved: Only value 0 is allowed.

Receive message	Data value	Meaning								
	UNS16 (2 byte)	<p>Index Signal number 1 of the send message 1</p> <p>SERCOS parameter <a href="#">Siehe 'SERCOS parameter' auf Seite 77.</a> Requirement: 'Signal typ' = 0 (SERCOS)</p> <p>Special signal <a href="#">Siehe 'Special Signals' auf Seite 75.</a> Requirement: 'Signal typ' = 2 (Special)</p>								
	UNS08 (1 byte)	<p>Length in bits The data length of a signal can be limited by specifying 'Length in bits'.</p> <p>Example: Signal data length bbbb aaaa (1 byte). User data bit 0..3 'Length in bits' = 4 Transmitted value: aaaa</p> <p>With 'Attribute send signal bit 2', you can set if the higher-order bits are omitted or the signal is limited to the maximum displayable value.</p>								
	UNS08 (1 byte)	<p>Shift in bits <sup>2)</sup> The entered value is used to specify the start bit of the signal in the message. (0..63 bit)</p> <p>Example: 3 Signals in a send message Signal 1; size 1 byte: shift in bit = 0 Signal 2; size 2 byte: shift in bit = 8 Signal 3; size 1 byte: shift in bit = 24</p>								
	UNS08 (1 byte)	<p>Attribute receive signal</p> <p>Setting of the signal characteristics</p> <table border="1"> <thead> <tr> <th>Bit</th> <th>Value</th> <th>Meaning</th> </tr> </thead> <tbody> <tr> <td rowspan="2">0 <sup>1)</sup></td> <td>0</td> <td>No inverted control signal included</td> </tr> <tr> <td>1</td> <td>The inverter checks the received signal. In the case of a plausibility error, the entire message is rejected.</td> </tr> </tbody> </table> <p>A maximum of 1 inverted control signal can be transmitted per receive message.</p>	Bit	Value	Meaning	0 <sup>1)</sup>	0	No inverted control signal included	1	The inverter checks the received signal. In the case of a plausibility error, the entire message is rejected.
Bit	Value	Meaning								
0 <sup>1)</sup>	0	No inverted control signal included								
	1	The inverter checks the received signal. In the case of a plausibility error, the entire message is rejected.								
Configuration	Data value	Meaning								
Transmission rate	UNS16 (2 byte)	<p>Transmission rate After the last signal of the last message, the transmission rate is entered in kBaud.</p>								
The end	Data value	Meaning								
	UNS08 (1 byte)	<p>The end At the end of the 'Free CAN message configuration', an element with the content 0 bytes must be available</p>								

1) Inverted signal

One signal per message can be inverted for checking the plausibility of the setpoint and actual values.

If a signal is selected for inverting, the following number of bits according to the data length of the signal are automatically reserved.

If a message is received with a difference between non-inverted and inverted signal, it will be ignored. The drive will generate

an error message if two successive errors of the inverted signal are detected.

2) Example:

Send message with 8 byte (4 signals with 2 byte)

Bit 0-7	Bit 8-15	Bit 16-23	Bit 24-31	Bit 32-39	Bit 40-47	Bit 48-55	Bit 56-63
Signal 1 (2 byte) 'Shift in bits': 0							
		Signal 2 (2 byte) 'Shift in bits': 16					
				Signal 3 (2 byte) 'Shift in bits': 32			
						Signal 4 (2 byte) 'Shift in bits': 48	



Activate the telegram failure monitoring so that the motor coasts down (setpoint 0 %M<sub>N</sub>) during bus failures or bus interruptions.

### 8.1.2.2.1 Parametrization 'Free CAN message configuration'

ID34091 is used to parametrize the 'Free CAN message configuration'.

ID34091 'User list 3' is a 'System-internal parameter'. The parameter must be enabled for configuration.

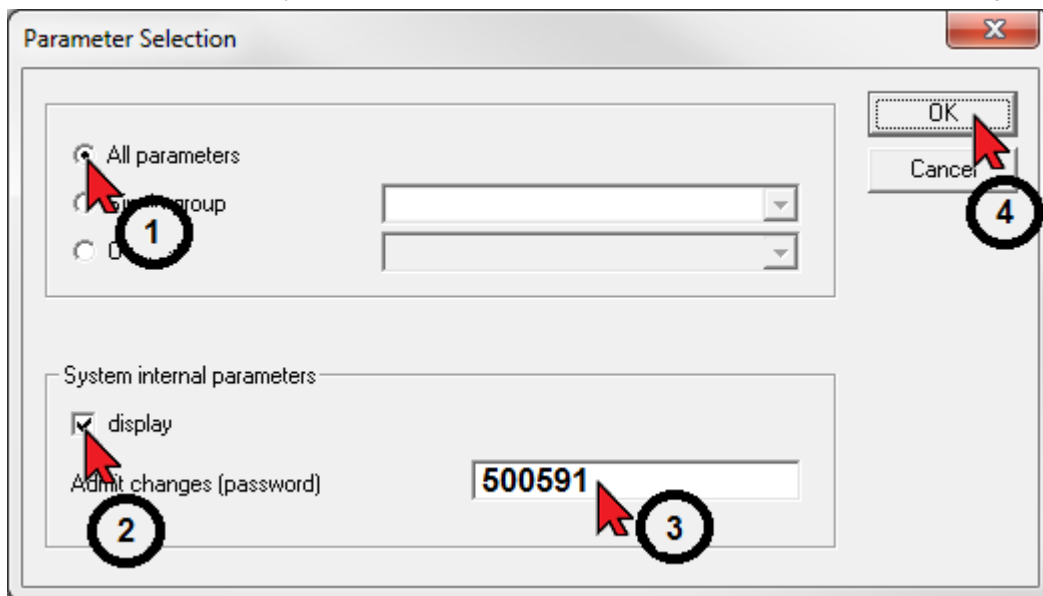

With the search function, you can jump directly to the entered parameter.

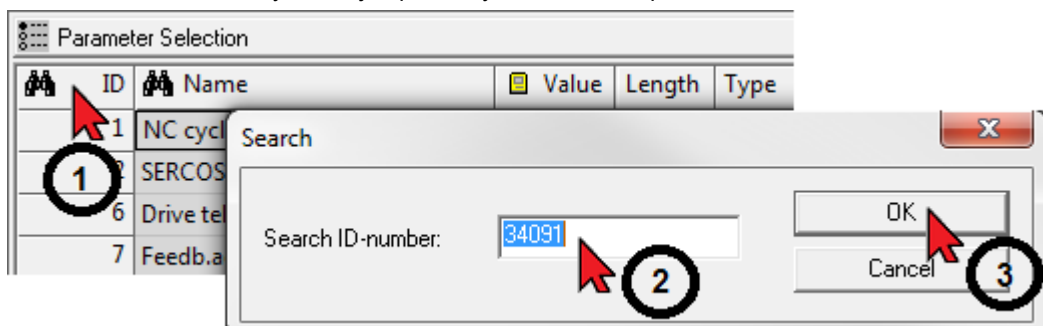



Enter the list length. The list length is application-specific and must be adapted to the CAN configuration.  
 (Click on the left mouse button, wait shortly and click again)

Recommended starting value: 50

Parameter Selection				
ID	Name	Value	Length	Type
34091	User list 3	0	*2	Hex

Description of a list element

Parameter Selection						
ID	Name	Value	Unit	Length	Type	Remark
34091	User list 3	50		*2	Hex	
34091-1	[maximum]	[2054]				
34091-2	Selection mode	01		1	Hex	Mode: Free CAN message configuration
34091-3		00			Hex	
34091-4		0000			Hex	
34091-5		0000			Hex	

- 1) Click on the folder icon to open and close the list.
- 2) Free text input
- 3) Input value list element, format hex, dec ... see 5
- 4) Length in bytes



The length in bytes must be adapted to the content of the list element.

- 5) Format, right mouse click
- 6) Free text input

Sample configuration:

Communication: inverter to controller

- Status word
- Actual speed value
- Actual torque current
- Actual magnetizing current
- Motor temperature
- Inverter, cold plate temperature
- Diagnostic number
- IGBT temperature

Communication: Control to the inverter

- Status word
- Speed setpoint
- Positive torque limit
- Negative torque limit

Transmission rate 500 kBaud, cyclical

Free CAN message configuration	
Selection mode	01
Total of send messages	2

<b>Send message 1</b>	
<b>CAN Identifier send messages 1</b>	0283
<b>Cycle in ms</b>	5
<b>Data length in byte</b>	8 (sum of signals 1 - 4 'length in bit' --- maximum permissible: 8 bytes)
<b>Attribute</b>	00 (send cyclically)
<b>Total of signals</b>	4

	<b>Signal 1</b>	<b>Signal 2</b>	<b>Signal 3</b>	<b>Signal 4</b>
<b>Signal type</b>	2	2	2	2
<b>Subindex</b>	0	0	0	0
<b>Index</b>	3 (Status word)	5 (Actual speed value)	25 (Actual torque current)	26 (Actual magnetizing current)
<b>Length in bits</b>	16 (2 Byte)	16 (2 Byte)	16 (2 Byte)	16 (2 Byte)
<b>Shift in bits (Start bit in the send message)</b>	0	16	32	48
<b>Attribute send signal</b>	0x00	0x02	0x02	0x02

<b>Send message 2</b>	
<b>CAN Identifier send messages 1</b>	0285
<b>Cycle in ms</b>	5
<b>Data length in byte</b>	8 (sum of signals 1 - 4 'length in bit' --- maximum permissible: 8 bytes)
<b>Attribute</b>	00 (send cyclically)
<b>Total of signals</b>	4

	<b>Signal 1</b>	<b>Signal 2</b>	<b>Signal 3</b>	<b>Signal 4</b>
<b>Signal type</b>	2	2	2	2
<b>Subindex</b>	0	0	0	0
<b>Index</b>	7 (Motor temperature)	8 (Inverter, cold plate temperature)	21 (Diagnostic number)	27 (IGBT temperature)
<b>Length in bits</b>	16 (2 Byte)	16 (2 Byte)	16 (2 Byte) <sup>1)</sup>	16 (2 Byte)
<b>Shift in bits (Start bit in the send message)</b>	0	16	32	48
<b>Attribute send signal</b>	0x02	0x02	0x00	0x02

1) Original 32 bit, diagnostic numbers according to documentation < 16 bits, therefore shortened

<b>Free CAN message configuration</b>	
<b>Total of receive messages</b>	1

<b>Receive message 1</b>	
<b>CAN Identifier receive messages 1</b>	0184
<b>Monitoring time in ms</b>	50
<b>Data length in byte</b>	8 (sum of signals 1 - 4 'length in bit' --- maximum permissible: 8 bytes)
<b>Attribute</b>	00 (without function)
<b>Total of signals</b>	4

	<b>Signal 1</b>	<b>Signal 2</b>	<b>Signal 3</b>	<b>Signal 4</b>
<b>Signal type</b>	2	2	2	2

	Signal 1	Signal 2	Signal 3	Signal 4
Subindex	0	0	0	0
Index	4 (Status word)	6 (Speed setpoint)	13 (Positive torque limit)	14 (Negative torque limit)
Length in bits	16 (2 Byte)	16 (2 Byte)	16 (2 Byte)	16 (2 Byte)
Shift in bits (Start bit in the send message)	0	16	32	48
Attribute receive signal	0x00	0x00	0x00	0x00

Free CAN message configuration	
Transmission rate in kBaud	500
End	00

### 8.1.2.2.2 Special Signals

Available 'Special Signals'

Index	Data type	Meaning
1	UNS16	Message counter <sup>1)</sup>
2	UNS08	Checksum <sup>2)</sup>
3	UNS16	Status word formula student <sup>3)</sup>
4	UNS16	Control word formula student <sup>4)</sup>
5	SGN16	Actual speed value in 1/rpm
6	SGN16	Speed setpoint in 1/rpm
7	SGN16	Motor temperature in 0,1 °C
8	SGN16	Inverter, cold plate temperature in 0,1 °C
9-12	-	-
13	SGN16	Positive torque limit in 0,1 % Mn
14	SGN16	Negative torque limit in 0,1 % Mn
15-16	-	-
17	SGN16	Torque setpoint in 0,1 % Mn
18	SGN32	Speed setpoint in 0,0001/rpm
19	SGN16	Actual torque value in 0,1 % Mn
20	SGN32	Actual speed value in 0,0001/rpm
21	UNS32	Diagnostic number
22	UNS32	Error info 1
23	UNS32	Error info 2
24	UNS32	Error info 3
25	SGN16	Raw data for calculating 'actual torque current' I <sub>q</sub> <a href="#">Siehe 'Units' auf Seite 83.</a> Value of 16384 correspond to ID110 'Converter peak current'
26	SGN16	Raw data for calculating 'actual magnetizing current' (field weakening current) I <sub>d</sub> <a href="#">Siehe 'Units' auf Seite 83.</a> Value of 16384 correspond to ID110 'Converter peak current'
27	SGN16	IGBT temperature in 0,1 °C

#### 1) Message counter

The message counter can be activated as an additional monitoring. The receiver checks the validity of the message by means of the message counter.

For each transmit message, the inverter will set a 16 bit overflowing counter. Its value is incremented with every sending the message and can be evaluated by the receiver.

An error of a receive message will be detected if five successively received messages contain the same count. A simple step of the counter value will not cause an error.

## 2) Checksum

To any message, a checksum can be configured. It is calculated across each byte of the message with the bits relevant for the checksum set to 0.

If a message with incorrect checksum is received, it will be ignored. If two faulty checksums are received successively, the drive will generate an error message.

For example, if the checksum is configured in byte 8, it is calculated as follows:

Byte8 = Byte1 XOR Byte2 XOR Byte3 XOR Byte4 XOR Byte5 XOR Byte6 XOR Byte7 XOR 00h

## 3) Content of the 'AMK\_Status' status word

The system status and the command acknowledgments are displayed via the status word.

Name	Offset	Length in bits	Meaning
AMK_bReserve	0	8	Reserved
AMK_bSystemReady	8	1	System ready (SBM)
AMK_bError	9	1	Error
AMK_bWarn	10	1	Warning
AMK_bQuitDcOn	11	1	HV activation acknowledgment
AMK_bDcOn	12	1	HV activation level
AMK_bQuitInverterOn	13	1	Controller enable acknowledgment
AMK_bInverterOn	14	1	Controller enable level
AMK_bDerating	15	1	Derating (torque limitation active)

## 4) Content of the 'AMK\_Control' control word

The control word can be used to trigger the following commands in the inverter:

Name	Offset	Length in bits	Meaning
AMK_bReserve	0	8	Reserved
AMK_bInverterOn	8	1	Controller enable
AMK_bDcOn	9	1	HV activation
AMK_bEnable	10	1	Driver enable
AMK_bErrorReset	11	1	Remove error*
AMK_bReserve	12	4	Reserved

\*Setpoints must have the value 0, as otherwise the 'Remove error' command will not be executed.

### 8.1.2.2.3 SERCOS parameter

Available SERCOS parameter

R: Read

RW: Read and Write



The changes to the read and write parameters via the CAN bus are only temporary effective.

Index (ID)	Data type	Meaning	Access
38	SGN32	'Positive velocity limit'	RW
39	SGN32	'Negative velocity limit'	RW
40	SGN32	'Velocity feedback value'	R
43	UNS16	'Velocity polarity'	R
84	SGN16	'Torque feedback value'	R
85	UNS16	'Torque polarity'	R
100	UNS16	'Speed control proportional gain KP'	RW
101	UNS16	'Integral-action time speed control TN'	RW
102	UNS16	'Differentiating time speed control TD'	RW
109	UNS32	'Motor peak current'	R
110	UNS32	'Converter peak current'	R
111	UNS32	'Motor nominal current IN'	R
112	UNS32	'Converter nominal current'	R
113	UNS32	'Maximum speed'	R
114	UNS16	'Overload limit motor'	R
209	UNS32	'Lower adaption limit'	R
210	UNS32	'Upper adaption limit'	R
211	UNS16	'Proportional gain adaption'	R
212	UNS16	'Integral-action time adaption'	R
392	UNS16	'Velocity feedback filter'	RW
32768	UNS16	'Nominal motor voltage'	R
32769	UNS32	'Magnetising current' (field weakening current)	R
32770	UNS32	'Magnetising current 1'	R
32771	UNS16	'Nominal torque'	R
32772	UNS32	'Nominal velocity'	R
32773	UNS32	'Service bits'	R
32774	UNS16	'Rotor time constant'	R
32775	UNS16	'Pole number motor'	R
32776	UNS32	'Sine encoder period'	R
32780	SGN32	'Acceleration ramp'	RW
32781	UNS32	'Deceleration ramp'	RW
32782	UNS32	'Deceleration ramp RF inactive'	R
32800	UNS32	'AMK main operating mode'	R
32828	SGN32	'Current feedback phase U'	R
32829	SGN32	'Current feedback phase V'	R
32830	SGN32	'Current feedback phase W'	R
32831	UNS16	'Commutation angle'	R
32832	SGN16	'Encoder signal S2'	R
32833	SGN16	'Encoder signal S1'	R
32834	SGN16	'Torque current feedback'	R
32836	UNS16	'DC bus voltage'	R
32837	UNS16	'DC bus voltage monitoring'	R

Index (ID)	Data type	Meaning	Access
32901	UNS32	'Global service bits'	R
32904	UNS16	'Controller enable'	R
32913	UNS16	'Clear error'	R
32920	UNS16	'Overload time motor'	R
32928	UNS16	'Time filter 1'	RW
32929	UNS16	'Time filter 2'	RW
32932	UNS16	'Barrier frequency'	R
32933	UNS16	'Bandwidth'	R
32942	UNS32	'Service control'	R
32943	UNS16	'Warning time'	R
32953	UNS16	'Encoder type'	R
32989	UNS16	'Torque filter time'	R
32999	UNS16	'Overload limit inverter'	R
33100	UNS32	'Actual power value'	R
33101	UNS16	'Display overload inverter'	R
33102	UNS16	'Display overload motor'	R
33104	SGN32	'Position feedback modulo'	R
33116	SGN16	'Temperature internal'	R
33117	SGN16	'Temperature external'	R
33171	SGN32	'Active power (electrical)'	R
33172	SGN32	'Reactive power (electrical)'	R
33730	UNS16	'System booting'	R
33732	UNS16	'System reset'	R
34045	UNS16	'Inductance path D'	R
34046	UNS16	'Inductance path Q'	R
34050	UNS16	'Current path Q integral-action time TN'	RW
34052	UNS16	'Current path D integral-action time TN'	RW
34063	UNS32	'Time meter power'	R
34096	UNS32	'Standstill current motor'	R
34119	UNS32	'Torque constant Kt adaption'	R
34148	UNS16	'Voltage control proportional gain KP'	RW
34149	UNS16	'Voltage control integrating time TN'	RW
34151	UNS16	'Current path Q proportional gain KP'	RW
34152	UNS16	'Current path D proportional gain KP'	RW
34161	UNS16	'Production date motor'	R
34162	UNS32	'Serial number motor'	R
34164	UNS16	'Terminal resistance'	R
34166	UNS16	'Temperature sensor motor'	R
34167	UNS16	'Terminal Inductance'	R
34168	UNS16	'Time maximum current motor'	R
34177	UNS16	'Lower threshold current adaption'	RW
34178	UNS16	'Upper threshold current adaption'	RW
34179	UNS16	'Gradient path Q proportional gain'	RW
34180	UNS16	'Gradient path Q integral-action time'	RW
34199	SGN32	'Actual power value bipolar'	R
34203	UNS16	'Voltage at 25 degrees'	R
34204	UNS16	'Voltage at 75 degrees'	R
34205	UNS16	'Voltage at 125 degrees'	R
34215	SGN16	'Temperature IGBT'	R
34233	UNS16	'Phase resistance'	R
34234	UNS16	'Voltage constant Ke'	R

Index (ID)	Data type	Meaning	Access
34235	UNS16	'Increase motor voltage'	R
34243	UNS16	'Offset commutation'	RW
34266	UNS16	'Voltage reserve'	R
34281	SGN32	'Current setpoint ISQ'	R
34282	SGN32	'Current setpoint ISD'	R
34298	UNS16	'Torque feedback filter'	R
34299	SGN32	'Velocity setpoint in control'	R
34300	SGN32	'Velocity actual value in control'	R
34301	SGN16	'Torque setpoint filter input'	R
34302	SGN16	'Torque setpoint filter output'	R

### 3586 'System diagnostics: Special software message'

<ul style="list-style-type: none"> <li>CAN bus: Error during initialization</li> </ul>			
<b>Device</b>	<b>FSE</b>		
<b>Description</b>			
<b>Class</b>	Error		
<b>Drive behaviour</b>	System run-up aborted		
<b>Device behaviour</b>			
<b>Additional information (Info AMK service)</b>			
	Info1	0	Invalid CAN configuration mode (ID34091-2)
		1	Configured index (ID) not found
		2	Invalid signal type
		3	Length of the configuration does not match the selected messages and signals
		4	Invalid transmission rate
		5	CAN module error
<b>Error removal</b>	<ul style="list-style-type: none"> <li>Restart device</li> <li>AMK service</li> </ul>		

### 3587 'System diagnostics: Special software message'

<ul style="list-style-type: none"> <li>Error during operation</li> </ul>			
<b>Device</b>	<b>FSE</b>		
<b>Description</b>			
<b>Class</b>	Error		
<b>Drive behaviour</b>	Coast to stop		
<b>Device behaviour</b>			
<b>Additional information (Info AMK service)</b>			
	Info1	0	Failure of setpoint message
		1	Checksum error
		2	Error in message counter
		3	Implausible signals (during inverted transmission)
		4	Unknown message received
		5	Message with wrong length received
		6	Error on transmission, possibly CAN not connected
<b>Error removal</b>	<ul style="list-style-type: none"> <li>Restart device</li> <li>AMK service</li> </ul>		

## 8.2 FSE firmware functional description

The torque at the servo motor is controlled subject to the setpoint (accelerator position). The setpoint for the inverters is specified via a higher-level CAN controller. The inverters can operate the servomotors in torque control (open loop) or speed control (closed loop) mode. Speed control versus torque control, the advantage of speed control is that the motor speed can be limited dynamically in addition to the limitation of the torque.

### 8.2.1 Controller structure

Simplified diagram of the controller structure:

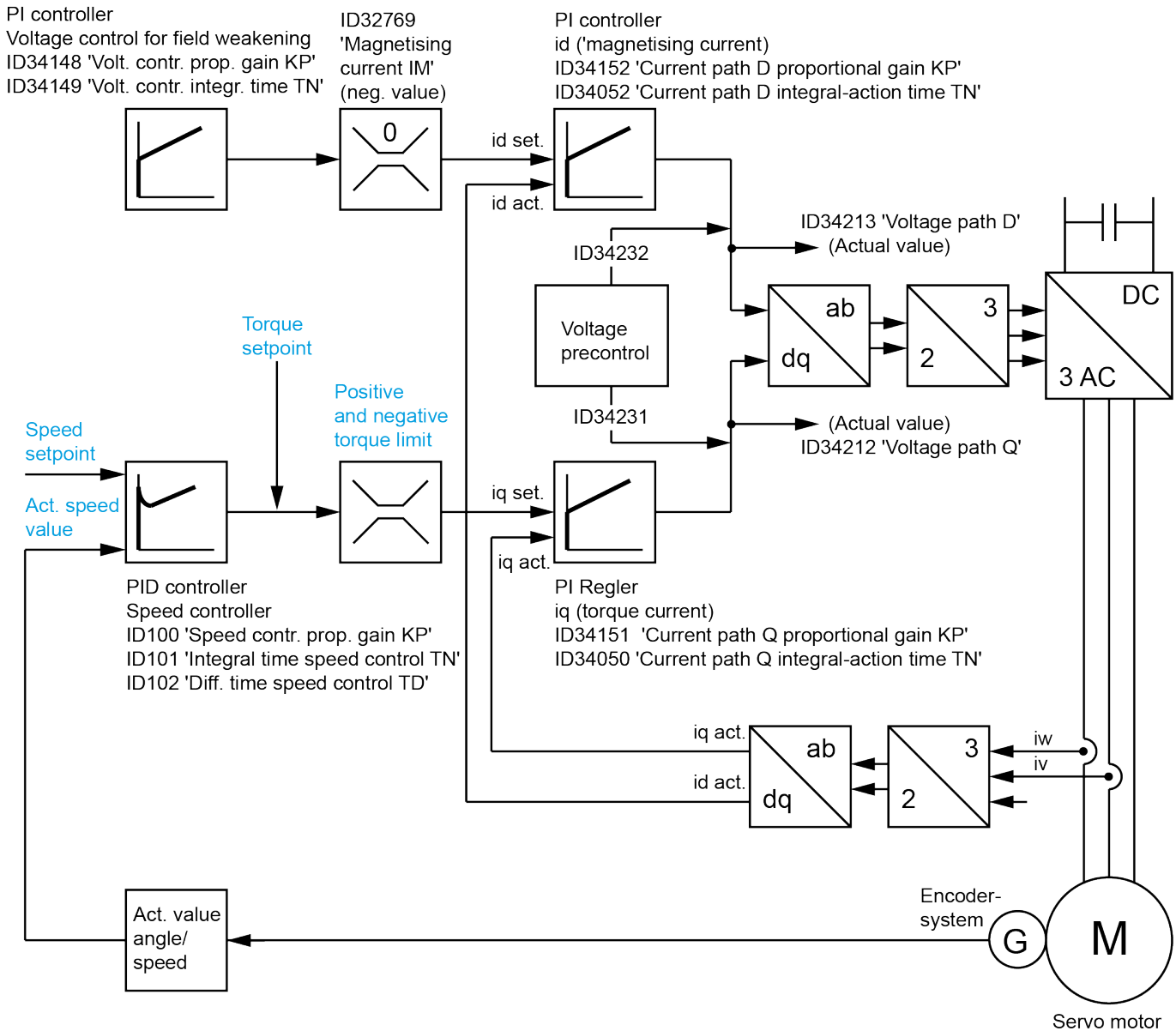

Label	CAN Variable ('Fixed CAN configuration')	CAN Variable ('Free CAN configuration')	
		Index	Meaning
Speed setpoint	AMK_TargetVelocity	6	Speed setpoint in 1/rpm
		18	Speed setpoint in 0,0001/rpm
Torque setpoint	-	17	Torque setpoint in 0,1 % Mn



Label	CAN Variable ('Fixed CAN configuration')	CAN Variable ('Free CAN configuration')	
Actual speed value	AMK_ActualVelocity	<b>Index</b>	<b>Meaning</b>
		5	Actual speed value in 1/rpm
		20	Actual speed value in 0,0001/rpm
Positive torque limit	AMK_TorqueLimitPositiv	<b>Index</b>	<b>Meaning</b>
		13	Positive torque limit in 0,1 % Mn
Negative torque limit	AMK_TorqueLimitNegativ	<b>Index</b>	<b>Meaning</b>
		14	Negative torque limit in 0,1 % Mn

### 8.2.2 Driving modes

NOTE	
<b>Material damage!</b>	<b>Destruction of the battery!</b> Impermissible charging and discharging currents will destroy the battery.
	<b>Preventive measures:</b> When defining the acceleration and braking torque, it must be ensured that the permissible charging and discharging currents of the battery are observed.

Driving mode	Description	CAN Variable ('Fixed CAN configuration')	CAN Variable ('Free CAN configuration')	
Forward acceleration	Speed setpoint = required positive speed [1/min]	AMK_TargetVelocity	<b>Index</b>	<b>Meaning</b>
			6	Speed setpoint in 1/rpm
			18	Speed setpoint in 0,0001/rpm
	Positive torque limitation = required positive acceleration torque [0,1 %M <sub>N</sub> ]	AMK_TorqueLimitPositiv	<b>Index</b>	<b>Meaning</b>
			13	Positive torque limit in 0,1 % Mn
	Negative torque limit = (negative sign) required negative deceleration torque [0,1 %M <sub>N</sub> ] <sup>1)</sup>	AMK_TorqueLimitNegativ	<b>Index</b>	<b>Meaning</b>
			14	Negative torque limit in 0,1 % Mn
Coasting	Speed setpoint = any speed [1/min]	AMK_TargetVelocity	<b>Index</b>	<b>Meaning</b>
			6	Speed setpoint in 1/rpm
			18	Speed setpoint in 0,0001/rpm
	Positive torque limitation = 0 [0,1 %M <sub>N</sub> ]	AMK_TorqueLimitPositiv	<b>Index</b>	<b>Meaning</b>
			13	Positive torque limit in 0,1 % Mn
	Negative torque limitation = 0 [0,1 %M <sub>N</sub> ]	AMK_TorqueLimitNegativ	<b>Index</b>	<b>Meaning</b>
			14	Negative torque limit in 0,1 % Mn
Brakes on 0 1/min with positive speed value	Speed setpoint = 0 [1/min]	AMK_TargetVelocity	<b>Index</b>	<b>Meaning</b>
			6	Speed setpoint in 1/rpm
			18	Speed setpoint in 0,0001/rpm
	Positive torque limitation = 0 [0,1 %M <sub>N</sub> ]	AMK_TorqueLimitPositiv	<b>Index</b>	<b>Meaning</b>
			13	Positive torque limit in 0,1 % Mn
	Negative torque limitation = (negative sign) required negative deceleration torque [0,1 %M <sub>N</sub> ]	AMK_TorqueLimitNegativ	<b>Index</b>	<b>Meaning</b>
			14	Negative torque limit in 0,1 % Mn

Driving mode	Description	CAN Variable ('Fixed CAN configuration')	CAN Variable ('Free CAN configuration')	
			Index	Meaning
Brakes on 0 1/min with negative speed value	Speed setpoint = 0 [1/min]	AMK_TargetVelocity	6	Speed setpoint in 1/rpm
			18	Speed setpoint in 0,0001/rpm
	Positive torque limitation = required positive deceleration torque [0,1 %M <sub>N</sub> ]	AMK_TorqueLimitPositiv	13	Positive torque limit in 0,1 % Mn
Reverse acceleration	Negative torque limitation = 0 [0,1 %M <sub>N</sub> ]	AMK_TorqueLimitNegativ	14	Negative torque limit in 0,1 % Mn
	Speed setpoint = (negative sign) required speed [1/min]	AMK_TargetVelocity	6	Speed setpoint in 1/rpm
			18	Speed setpoint in 0,0001/rpm
Reverse acceleration	Positive torque limitation = any [0,1 %M <sub>N</sub> ]	AMK_TorqueLimitPositiv	13	Positive torque limit in 0,1 % Mn
	Negative torque limitation = (negative sign) acceleration torque [0,1 %M <sub>N</sub> ]	AMK_TorqueLimitNegativ	14	Negative torque limit in 0,1 % Mn

1) Exceeds the actual speed the speed setpoint, for example when driving downhill the motor brakes with the given deceleration torque.

### 3585 'System diagnostics: Special software message'

• CAN bus: Error during initialization							
<b>Device</b>	<b>FSE</b>						
<b>Description</b>							
<b>Class</b>	Error						
<b>Drive behaviour</b>	System run-up aborted / Coast to stop						
<b>Device behaviour</b>							
<b>Additional information (Info AMK service)</b>							
	Info1	1	Info2	3	Info3	1	Upper voltage limit ID32798-3 < Lower voltage limit ID32798-4
						2	Upper voltage limit ID32798-3 too large or lower voltage limit ID32798-4 too small
						8	Incorrect settings Voltage limiter ID32798-3 < ID32798-7 or ID32798-4 > ID32798-10
	2	Info2	1	Info3	2	Limits Torque reduction Temperature IGBT interchanged ID32798-8 > = ID32798-9	
					3	Limits Torque reduction Temperature Motor interchanged ID32798-11 > = ID32798-12	
					4	Limits Torque reduction Temperature inverter interchanged ID32798-5 > = ID32798-6	
	<b>Error removal</b>	<ul style="list-style-type: none"> <li>Restart device</li> <li>AMK service</li> </ul>					

## 8.2.3 Units

### Torque

All system torque values refer to ID32771 'Nominal torque' and are specified to 0.1 %  $M_N$  of its value. Please refer to the type plate or data sheet for the motor for the parameter value. The key reference for the torque data is ID111 'Motor nominal current IN'.

### Id and Iq

The currents are related to the device-specific value in ID110 'Converter peak current'. The actual current in A is calculated as follows:

$$I_q = \frac{AMK\_TorqueCurrent * ID110}{16384}$$

$$I_d = \frac{AMK\_MagnetizingCurrent * ID110}{16384}$$

## 8.2.4 Drive behavior in the event of an error

In the event of an error, a CAN error message 'AMK\_ErrorInfo' is generated by the inverter and the 'AMK\_bError' CAN error bit is set. Depending on the cause of the error, the motor will be switched to torque-free operation or the trigger signals for activating the power output stages will be blocked at two channels (identical to X15 EF / EF2 = 0).

**Torque-free** means that motor control continues to be active at a speed setpoint of 0%  $M_N$ . The motor behaves in the same way as it does when coasting down. If  $N_{act} = 0$  rpm, motor control is deactivated and the 'AMK\_bQuitInverterOn' CAN status signal is reset.

**Power output stage activation blocked** means that motor control is deactivated and the 'AMK\_bQuitInverterOn' CAN status signal is reset. Providing that the axis is rotating, the rotor's permanent magnets induce an inverse voltage at the motor connections of the inverter. The behavior of the motor (coasting / braking) depends on whether the induced voltage is > DC link (HV voltage). In this case, the circuit closes via the free-wheeling diodes in the power transistor and braking occurs (DC braking). The braking torque is subject to the actual speed value. If the induced voltage decreases to < DC link (HV voltage), the motor coasts down.

The induced inverse voltage in the DC link (HV voltage) is calculated using the following formula and must not be more than 800 VDC:

ID34234 'Voltage constant Ke' x actual speed value x  $\sqrt{2}$  / 1,000



To ensure that the motor is reliably disconnected, a suitable disconnecter must be installed.

Overview of drive behavior in the event of an error / when resetting EF / EF2:

Situation	EF / EF2 (X15)	AMK_bError (CAN)	AMK_bQuitInverterOn (CAN)	Induced voltage > HV voltage	Behavior
1	1	1	1	No	Motor control: active Torque setpoint: 0% M <sub>N</sub> Motor behavior: coasts down
2	1	1	1	Yes	Motor control: active Torque setpoint: 0% M <sub>N</sub> Motor behavior: coasts down
3	1	1	0	No	Motor control: deactivated <sup>1)</sup> Torque setpoint: - Motor behavior: coasts down (behavior identical to situation 5)
4	1	1	0	Yes	Motor control: deactivated <sup>1)</sup> Torque setpoint: - Motor behavior: generator (recuperative) operation (behavior identical to situation 6)
5	0	1	0	No	Motor control: deactivated <sup>1)</sup> Torque setpoint: - Motor behavior: coasts down
6	0	1	0	Yes	Motor control: deactivated <sup>1)</sup> Torque setpoint: - Motor behavior: generator (recuperative) operation

1) The trigger signals for activating the power output stages are blocked at two channels.



It is only ever the drive system of the inverter that generates the error that is switched to torque-free operation; the other drive systems continue to be controlled as normal.

The program for the higher-level CAN controller must be designed so that errors are detected and the other drive systems are switched off based on the current situation.

### 8.2.5 Diagram for error scenarios

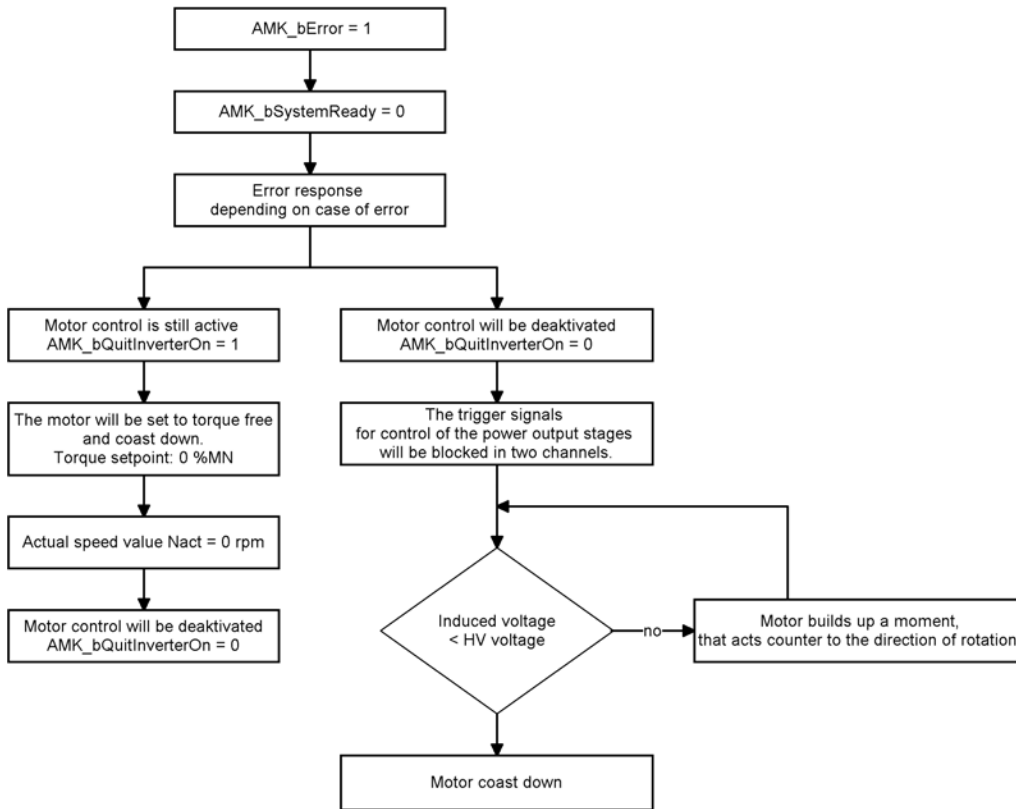

### 8.2.6 'Remove error' diagram

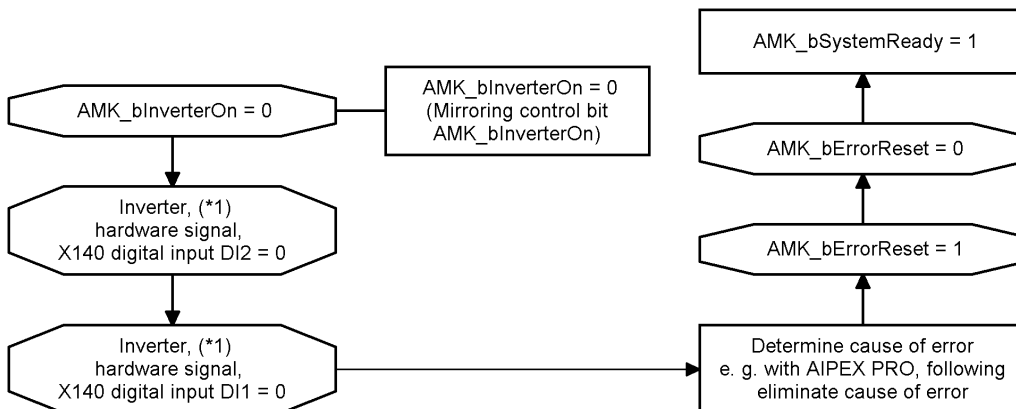

1) Optional



The 'AMK\_bErrorReset' command and the following restart can also be carried out during the axis is rotating. (Requirement: Setpoints = 0)

### 8.2.7 Torque limitation

Operating the motor with torque levels above the nominal torque is permitted within clearly defined limits. If the limits are exceeded, the drive generates a diagnostic message. The power output stage is switched off and the motor coasts down. To enable the inverter to be operated in a fault-free manner, even at maximum load, the maximum motor torque is reduced automatically.

Derating is based on the following measured variables:

- Motor temperature
- Inverter power supply (IGBT) temperature

- Inverter cold plate temperature
- Overload as per inverter current integral
- Overload as per motor current integral
- Undervoltage or overvoltage in the HV circuit

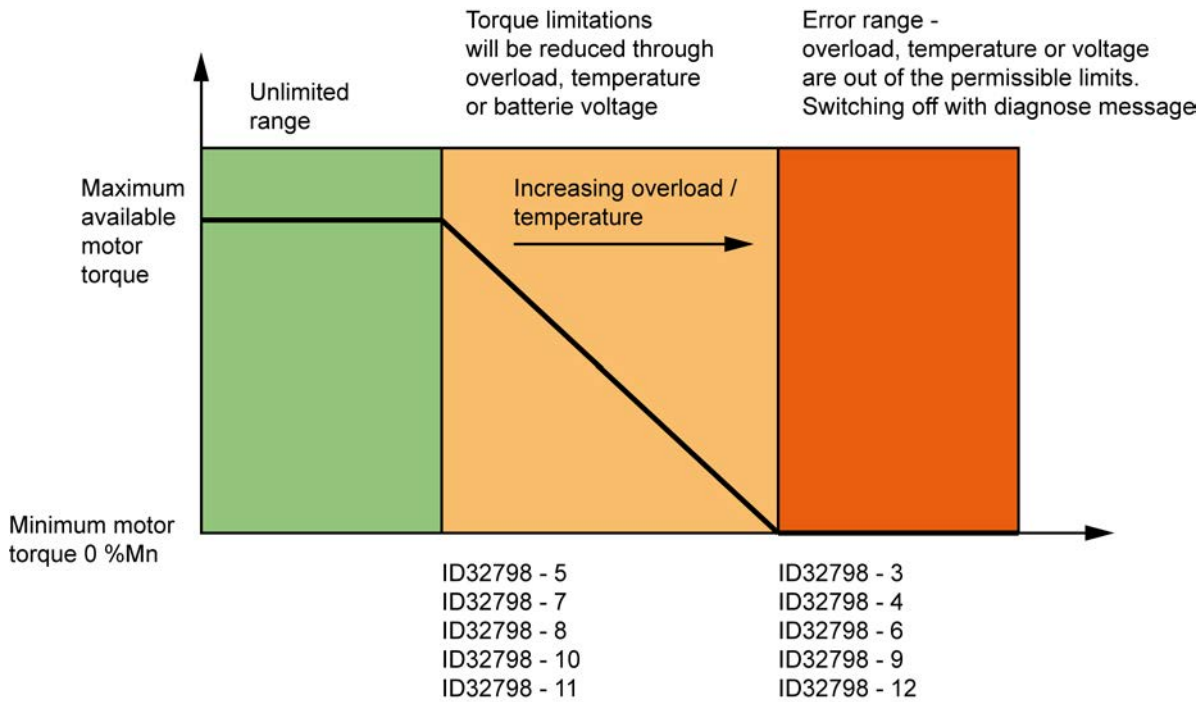

Derating calculates a limit for the torque current. To ensure that this limit is not exceeded, the torque limits are influenced. Only the positive or negative torque limit that is currently active during operation is influenced.

No error messages are issued when the voltage limits are exceeded. However, torque cannot be taken from the motor that would cause the limits to be exceeded further.

If power is being reduced, this is signaled via X140 BO3 and via the CAN bus with CAN variable 'AMK\_bDerating'.

**Configuring torque limitation:**

<b>Temperature Motor</b>	Temperature measured by KTY in the motor winding, connected to terminal X12 at the inverter	
	ID32798 'User list 1'	
	ID32798 - 11	Motor temperature at which full torque is available
	ID32798 - 12	Motor temperature at which no torque is available
<b>Temperature Inverter power supply (IGBT)</b>	Temperature measured (IGBT) by temperature model	
	ID32798 'User list 1'	
	ID32798 - 8	Power supply temperature at which full torque is available
	ID32798 - 9	Power supply temperature at which no torque is available
<b>Temperature Inverter cold plate</b>	Temperature measured by KTY on cold plate	
	ID32798 'User list 1'	
	ID32798 - 5	Inverter temperature at which full torque is available
	ID32798 - 6	Inverter temperature at which no torque is available
<b>Overload as per inverter current integral</b>	Always active, cannot be deactivated	
	ID32999 'Overload limit inverter' Threshold of the inverter current integral from which derating starts and a message is issued	

<b>Overload as per motor current integral</b> 1)	Activate the I <sup>2</sup> t monitoring of the servo motor in ID32773 'Service bits', bit 14	
	ID114 'Overload limit motor'	
	Threshold of the motor current integral from which derating starts and a message is issued.	
	Relevant motor parameters ID109 'Motor peak current' ID34096 'Standstill current motor' ID34168 'Time maximum current motor'	
<b>Undervoltage or overvoltage in the HV circuit</b>	ID32798 'User list 1'	
	ID32798 - 3	Maximum battery voltage (end-of-charge voltage)
	ID32798 - 4	Minimum battery voltage (deep discharge)
	ID32798 - 7	Start of reduction for end-of-charge voltage
	ID32798 - 10	Start of reduction for deep discharge protection



Configuration information: [Siehe 'FSE parameters' auf Seite 34.](#)

### 8.2.8 Battery protection

Basic battery protection that can prevent overvoltage and undervoltage in the battery is integrated in the FSE firmware.

If the battery voltage is between ID32798 - 7 and ID32798 - 3, the generator torque limit (the positive or negative torque limit depending on the current direction of rotation) is reduced linearly so that the end-of-charge voltage in ID32798 - 3 cannot be exceeded. If the battery voltage is between ID32798 - 10 and ID32798 - 4, the motor torque limit is reduced linearly so that it is not possible to fall below the deep discharge threshold in ID32798 - 4.



External battery monitoring must be used to evaluate the charging states of the individual battery cells.

### 8.3 Motor encoders

Inductive motor encoders are integrated into the DYNASYN DD5-14-10-POW-18600-B5 synchronous servo motors (AMK classification P). They are single-turn absolute encoders with a digital EnDat 2.2 light interface.

The main job of the motor encoder is to feed back the position of the rotor to the inverter. With field-based regulation, the current setpoints and current commutations are calculated from the rotor position. The synchronous motor requires an absolute measuring system that is aligned with the poles of the permanent magnets in the rotor. The evaluation electronics use the encoder signals to generate the actual speed value for the drive control.



To ensure correct commutation for synchronous motors, the encoder must be adjusted after it has been mounted on the motor shaft.

Contact AMK service!

The commutation offset defined during the encoder adjustment is stored in the encoder if it has an encoder store. If the position of the encoder changes in relation to the motor shaft (e.g., if the encoder is replaced), the commutation offset must be redefined, as otherwise it will not be possible to control the motor. AMK motors with absolute encoders and encoder stores are adjusted at the factory and delivered with a valid commutation offset.

## 9 Startup

### 9.1 Wiring the motor and supply cables

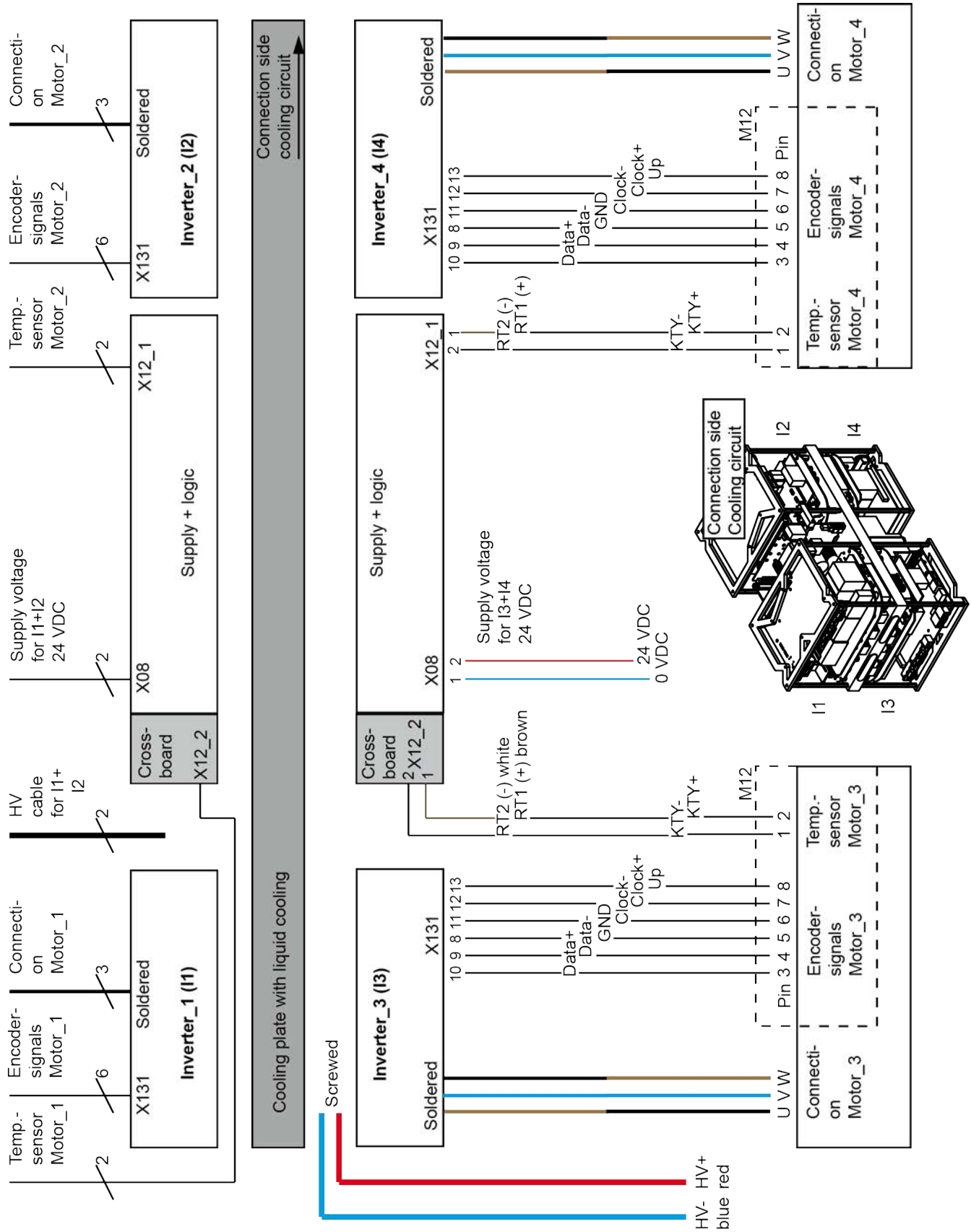



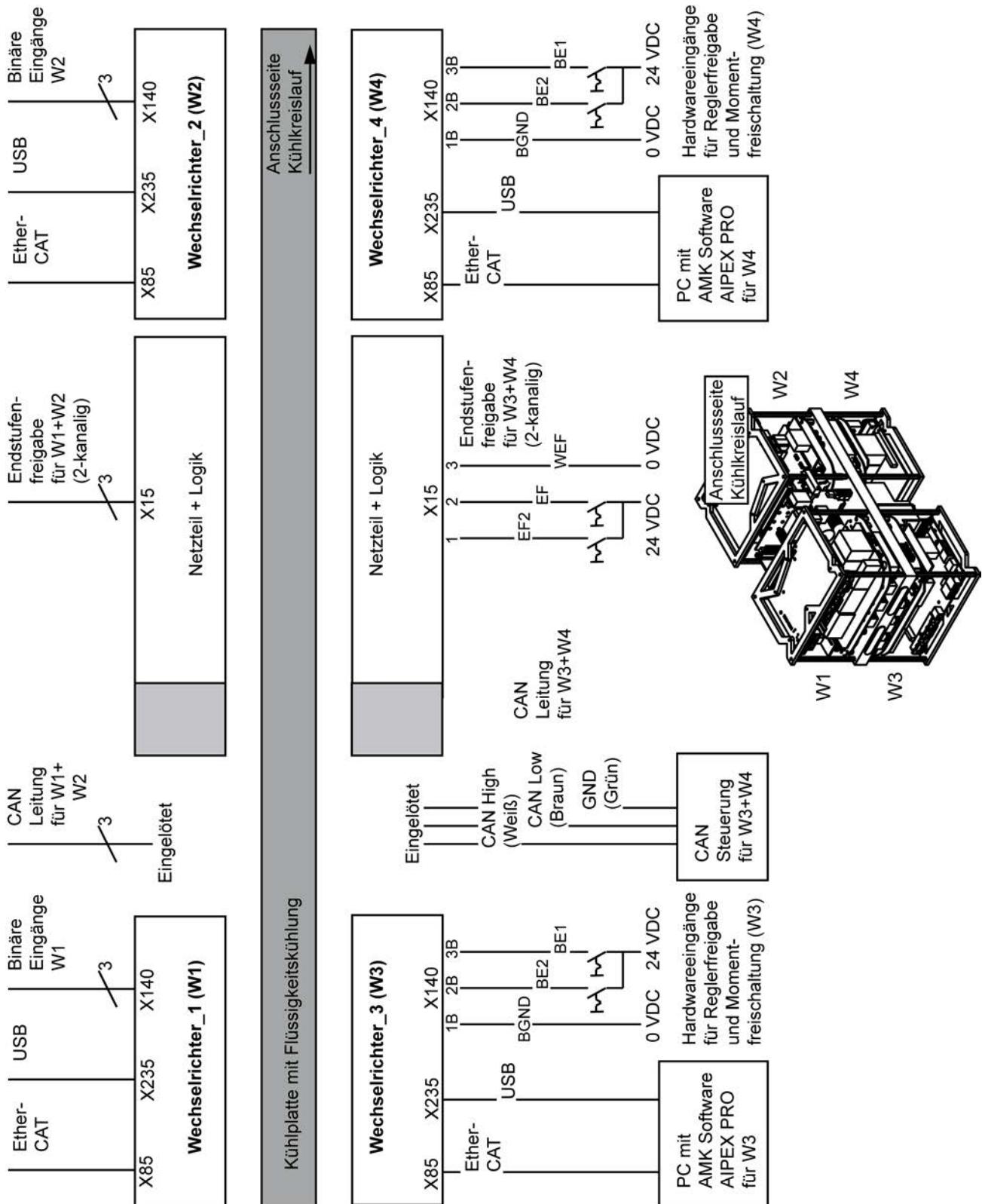

## 9.2 Wiring the interface and control cables



## 9.3 Startup with AIPEX PRO

Prior to startup, please read the following chapters in the Software description AIPEX PRO V3:

- AIPEX PRO → Program overview
- AIPEX PRO → Tabs
- AIPEX PRO → Menu bar

Step	To do	Detailed description
1	<p>Install AIPEX PRO on a PC with a Windows operating system and Ethernet and / or USB interface.</p>  <p>Components required</p> <ul style="list-style-type: none"> <li>• AIPEX: startup and parameter explorer</li> <li>• ATF: firmware update tool</li> <li>• USBCOM: driver for serial communication via USB</li> <li>• WinPcap: Windows packet capture library for access to EtherCAT</li> </ul>	<p>Software description AIPEX PRO V3 chapter: AIPEX PRO → Installation instructions</p>
2	<p>EtherCAT connection (recommended) Connect the PC's Ethernet connection to the X85 interface on the inverter.</p>  <p>EtherCAT must be activated in the AIPEX PRO communication settings.</p> <p>Alternative: USB connection Connect the PC's USB connection to the X235 interface on the inverter. (No other communication settings required)</p>	<p>Software description AIPEX PRO V3 chapter: AIPEX PRO → Communication between PC and AMK device → EtherCAT interface</p>
3	<p>Communication testing (EtherCAT connection)</p> <ul style="list-style-type: none"> <li>• Apply the 24 VDC supply voltage to inverter terminal X08</li> <li>• Launch AIPEX PRO</li> <li>• Following the initialization phase, the green 'communication icon' on the PC status bar indicates that there is an active connection between the PC (with AIPEX PRO) and the inverter.</li> </ul>	<p>Software description AIPEX PRO V3 chapter: AIPEX PRO → Communication between PC and AMK device → Testing communication</p>
4	<p>The following AIPEX PRO functions are required for startup, maintenance, service, etc. Test the functions.</p> <ul style="list-style-type: none"> <li>• Log in</li> <li>• Read and save the device data</li> <li>• Load an offline project on a device</li> <li>• Perform diagnosis with AIPEX PRO</li> <li>• Test generator</li> <li>• Configure oscilloscope</li> </ul>	<p>Software description AIPEX PRO V3 chapter: AIPEX PRO → Functions</p>
5	<p>Configure the inverter. The relevant parameters can be found in the Planning chapter:</p> <ul style="list-style-type: none"> <li>• <a href="#">Siehe 'Configuration' auf Seite 33.</a></li> <li>• <a href="#">Siehe 'Motor parameters' auf Seite 34.</a></li> <li>• <a href="#">Siehe 'CAN Bus communication ' auf Seite 61.</a></li> <li>• <a href="#">Siehe 'FSE parameters' auf Seite 34.</a></li> <li>• <a href="#">Siehe 'Default parameters' auf Seite 36.</a></li> <li>• <a href="#">Siehe 'Direction of rotation for motor shaft' auf Seite 37.</a></li> </ul>  <p>The modified parameters values are only activated once the system has been restarted.</p> <p>24 VDC OFF / ON (terminal X08)</p>	<p>Software description AIPEX PRO V3 chapter: AIPEX PRO → Tabs → Parameters</p>
6	<p>Activate motor control.</p>	<p><a href="#">Siehe 'On and off diagram 'Fixed CAN message configuration' auf Seite 91.</a></p>
7	<p>Optimize the speed control circuit, if necessary.</p>	<p><a href="#">Siehe 'Tuning the speed controller' auf Seite 94.</a></p>
8	<p>Test the specified setpoint via CAN bus.</p>	<p><a href="#">Siehe 'Driving modes' auf Seite 81.</a></p>

### 9.4 On and off diagram 'Fixed CAN message configuration'

The supply and hardware inputs are supplied, set, and reset via the terminals (Xxxx) at the inverters. The status and control signals (AMK\_ xxx) are read, set, and reset via a higher-level CAN controller.



The control signals must be sent cyclically at < 50 ms, as otherwise the telegram failure monitoring function will respond.

Each inverter must be activated separately.

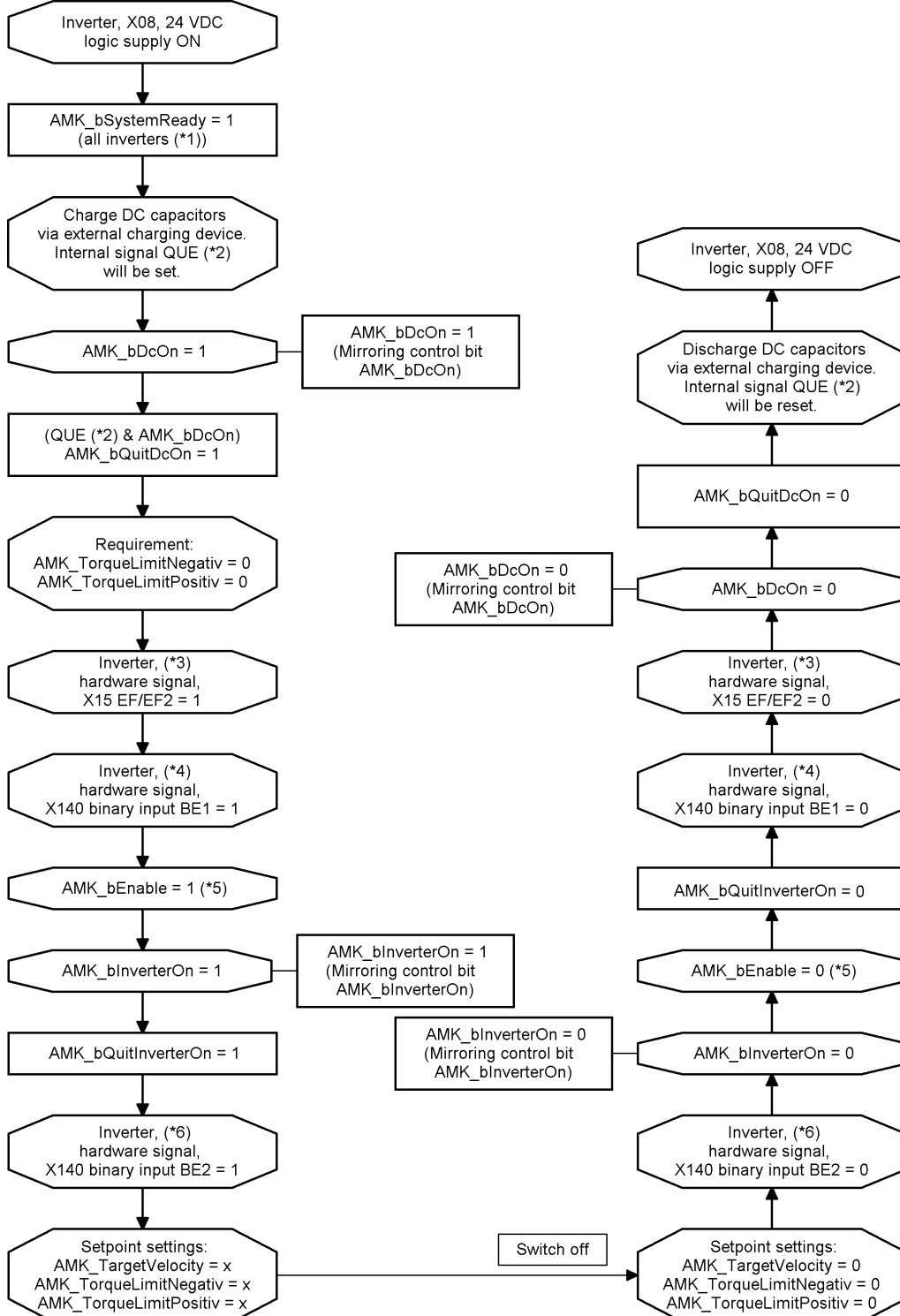

(\*1) Each inverter delivers an 'AMK\_bSystemReady' status signal (AMK SBM signal). All status signals have to be evaluated in a higher-level CAN controller.

(\*2) The internal QUE status signal is set as soon as the HV DC voltage > ID32837 'DC bus voltage monitoring'.

(\*3)  The first activation of the controller enable (after switching on the 24VDC supply) is only possible when the drive is stopped. The controller enable can then also be set when the drive is rotating.

(\*4) The EF / EF2 output stage enable may only be removed when the RF controller enable is switched off and when the motor is at a standstill. Switching off EF / EF2 during operation will generate an error message in the drive and the motor will coast down.

Interrupting the EF / EF2 control inputs blocks the trigger signals for activating the power output stages at two channels. The motor is then in a torque-free state but the drive system is not completely disconnected. If, in the event of an interruption, the motor speed is in the field weakening range, this can cause the motor to be braked. [Siehe 'Drive behavior in the event of an error' auf Seite 83.](#)

The power output stage is unblocked by setting the EF and EF2 signals.

Following the enable, the drive can be supplied with power by setting the RF controller enable (X140 BE1 = 1, 'AMK\_bEnable' = 1, 'AMK\_bInverterOn' = 1).



If the function is not used, the EF / EF2 control inputs can be permanently connected to 24 VDC.

(\*5) DI1 is similar to the terminal designation X15 (ignition key) in the automotive sector.

DI1 = 1 : controller enable RF possible

DI1 = 0 : controller enable RF blocked



If the function is not used, the BE1 hardware input can be permanently connected to 24 VDC.

(\*6) The 'AMK\_bEnable' control signal must be set and reset, but does not activate any function.

(\*7) Activating the predefined torque limits requires the DI2 hardware input to be set.

DI2 = 1 : torque limits active

DI2 = 0 : torque limits deactivated, motor without torque



If the function is not used, the BE2 hardware input can be permanently connected to 24 VDC.

### 9.5 On and off diagram 'Free CAN message configuration'

The supply and hardware inputs are supplied, set, and reset via the terminals (Xxxx) at the inverters. The status and control signals (AMK\_ xxx) are read, set, and reset via a higher-level CAN controller.



The control signals must be sent to match the created message configuration.

Each inverter must be activated separately.

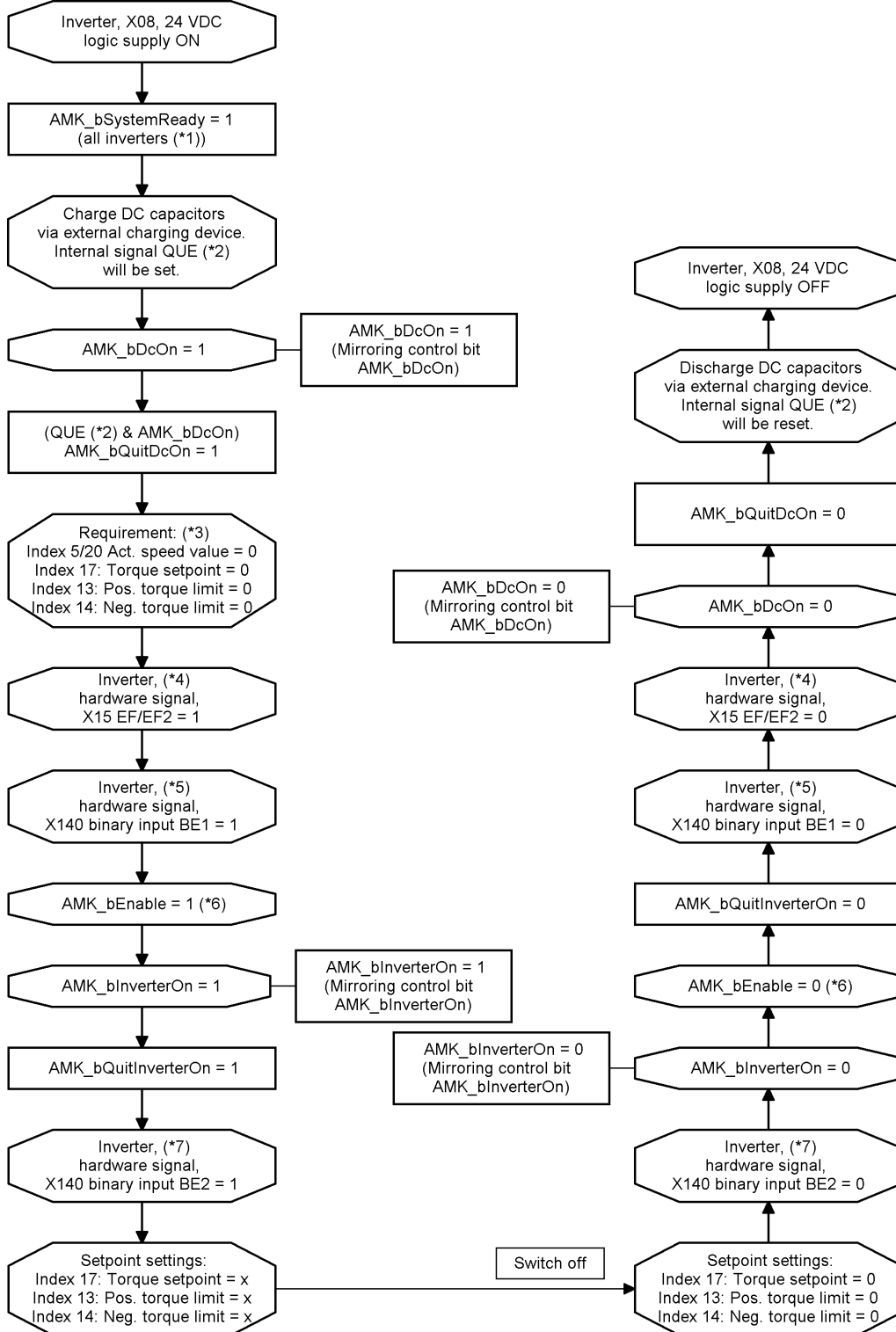

(\*1) Each inverter delivers an 'AMK\_bSystemReady' status signal (AMK SBM signal). All status signals have to be evaluated in a higher-level CAN controller.

(\*2) The internal QUE status signal is set as soon as the HV DC voltage > ID32837 'DC bus voltage monitoring'.

(\*3)  The first activation of the controller enable (after switching on the 24VDC supply) is only possible when the drive is stopped. The controller enable can then also be set when the drive is rotating.

(\*4) The EF / EF2 output stage enable may only be removed when the RF controller enable is switched off and when the motor is at a standstill. Switching off EF / EF2 during operation will generate an error message in the drive and the motor will coast down.

Interrupting the EF / EF2 control inputs blocks the trigger signals for activating the power output stages at two channels. The motor is then in a torque-free state but the drive system is not completely disconnected. If, in the event of an interruption, the motor speed is in the field weakening range, this can cause the motor to be braked. [Siehe 'Drive behavior in the event of an error' auf Seite 83.](#)

The power output stage is unblocked by setting the EF and EF2 signals.

Following the enable, the drive can be supplied with power by setting the RF controller enable (X140 BE1 = 1, 'AMK\_bEnable' = 1, 'AMK\_bInverterOn' = 1).



If the function is not used, the EF / EF2 control inputs can be permanently connected to 24 VDC.

(\*5) DI1 is similar to the terminal designation X15 (ignition key) in the automotive sector.

DI1 = 1 : controller enable RF possible

DI1 = 0 : controller enable RF blocked



If the function is not used, the BE1 hardware input can be permanently connected to 24 VDC.

(\*6) The 'AMK\_bEnable' control signal must be set and reset, but does not activate any function.

(\*7) Activating the predefined torque limits requires the DI2 hardware input to be set.

DI2 = 1 : torque limits active

DI2 = 0 : torque limits deactivated, motor without torque



If the function is not used, the BE2 hardware input can be permanently connected to 24 VDC.

## 9.6 Optimizing the current controller

With AMK synchronous servo motors, the current control parameters defined by AMK are transferred from the motor data sheet to the inverter via the motor database integrated in AIPEX PRO.

## 9.7 Tuning the speed controller

By means of the AIPEX PRO startup function, a square wave speed setpoint step-change is preset. The step response is recorded with the AIPEX PRO oscilloscope.

The controller parameters ID100 'Speed control proportional gain KP', ID101 'Integral-action time speed control TN' und ID102 'Differentiating time speed control TD' are displayed and tuned in the temporary parameter list and therefore are directly valid in the drive.

This chapter describes how to tune the speed controller by means of AIPEX PRO.

The Function descriptions (Part no. 203878), chapter 'Setting the control loop', describes the general procedure of tuning the speed controller.

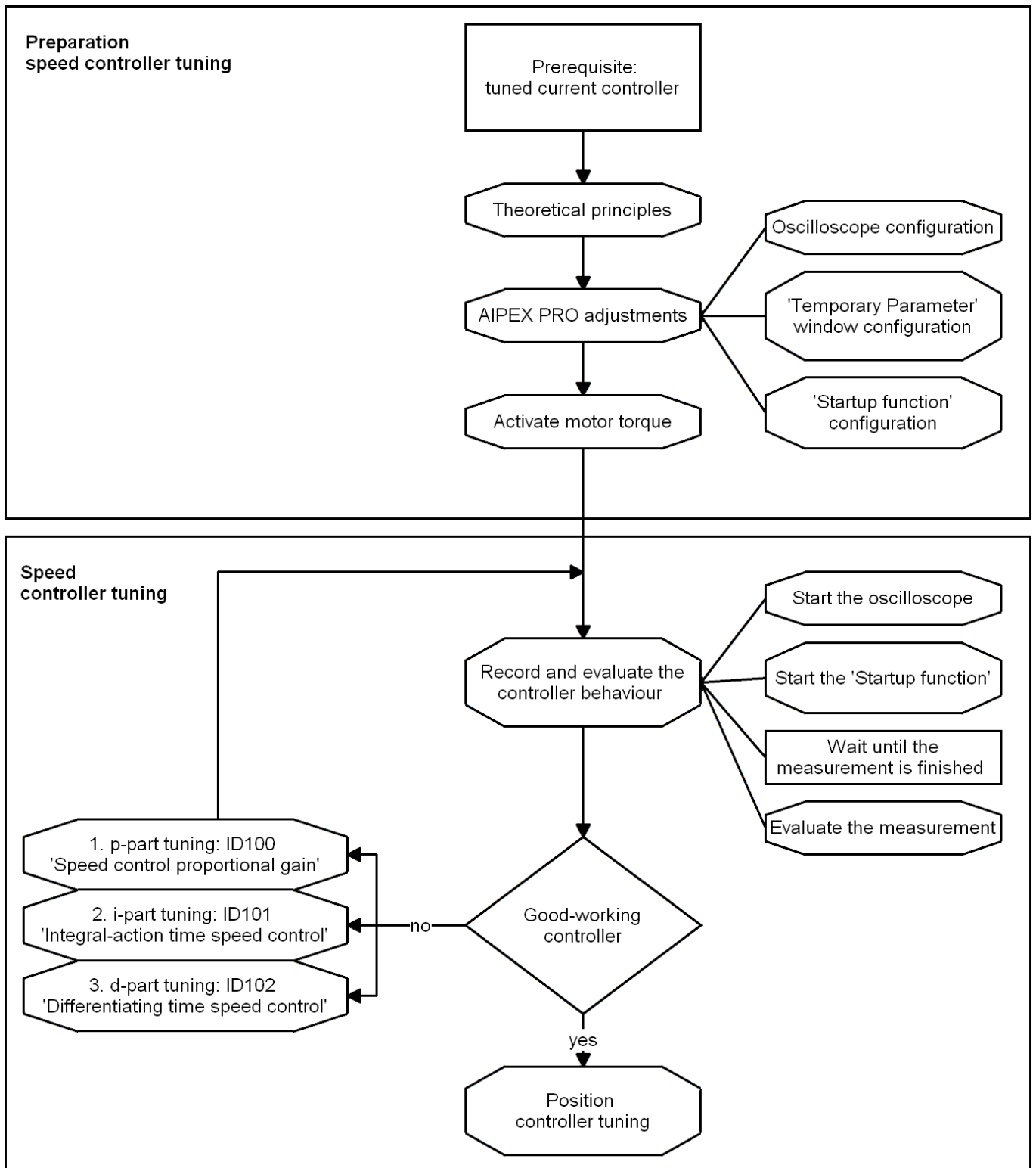

### 9.7.1 Theoretical basis

The PID speed controller needs to be set and optimised depending on the application.

The precise mathematical description of all parameters of the control circuit has been shown often to be rather extensive and difficult in practical applications. Therefore, a simple procedure shall be presented here by which the controller can be set practically.

For that, a speed step-change (without ramp) needs to be given as a reference variable at the input of the controller. The step response (speed actual value) should be recorded for evaluating the controller setting. When specifying the speed step, make sure that the drive remains operating below the torque limit.

Set the controller as follows:

1. Setting ID100 'Speed control proportional gain KP'  $K_p$ , with ID101 = 0 ( $T_n$ ), ID102 = 0 ( $T_d$ )
2. Setting ID101 'Integral-action time speed control TN'  $T_n$ , with ID100 = const. ( $K_p$ ), ID102 = 0 ( $T_d$ )
3. Setting ID102 'Differentiating time speed control TD'  $T_d$ , with ID100 = const. ( $K_p$ ), ID101 = const. ( $T_n$ )

**Step response of the optimised speed control circuit**

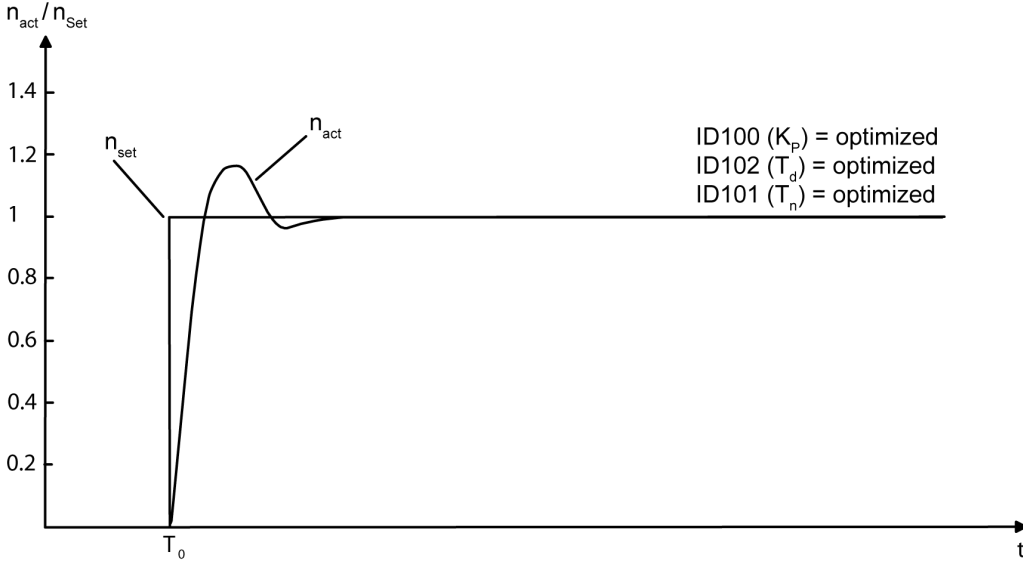

For an optimally set PID controller, the actual speed value may overshoot a setpoint step-change by no more than 20%.



Two PT1 filters can be configured at the output of the speed controller.  
See ID32928 'Time filter 1' and ID32929 'Time filter 2'

**Relevant parameters:**

Parameter	Name
ID100	'Speed control proportional gain KP'
ID101	'Integral-action time speed control TN'
ID102	'Differentiating time speed control TD'
ID32928	'Time filter 1'
ID32929	'Time filter 2'



### Setting the proportional gain $K_p$

Set ID102 ('Differentiating time speed control TD',  $T_d$ ) and ID101 ('Integral-action time speed control TN',  $T_n$ ) to 0, the controller then works as proportional controller.

By increasing ID100 'Speed control proportional gain KP'  $K_p$ , the controller should be made to overshoot (50 % overshoots). The actual speed has a course then similar to the curve with the solid line:

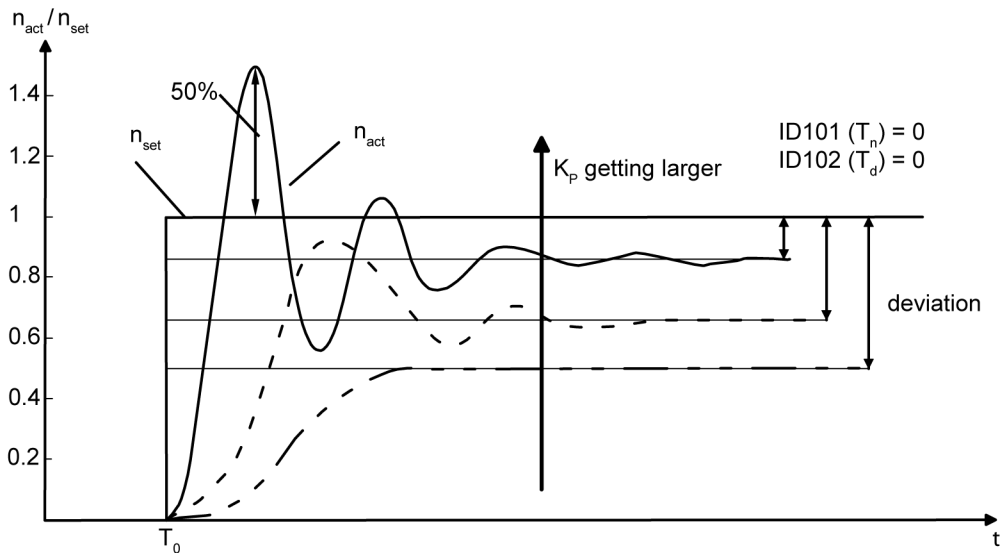

Halve the determined value for 'Speed control proportional gain KP'  $K_p$  and enter the halved value in ID100.

### Setting the reset time $T_n$

Using the integral proportion (I-proportion) in the controller, the controller deviation resulting from the P controller is adjusted. The integration time is reduced (starting at an initial value e.g. 100ms) until the settling time is minimal. If the reset time is set optimally, the actual speed value curve (jump answer) roughly follows the curve with the solid line:

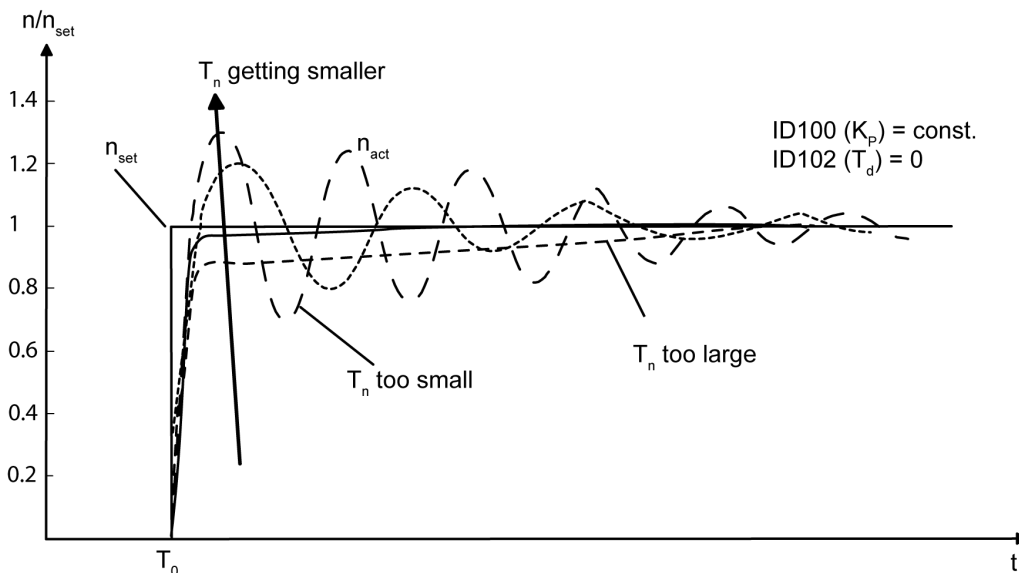

For an optimally set PI controller, the actual speed value may overshoot a setpoint jump by no more than 20% as an answer.

### Setting the differential time $T_d$

The differentiating time  $T_d$  is extended until the desired dampening of the jump answer is reached. The curve with the solid line serves as a reference point for setting the D-share.

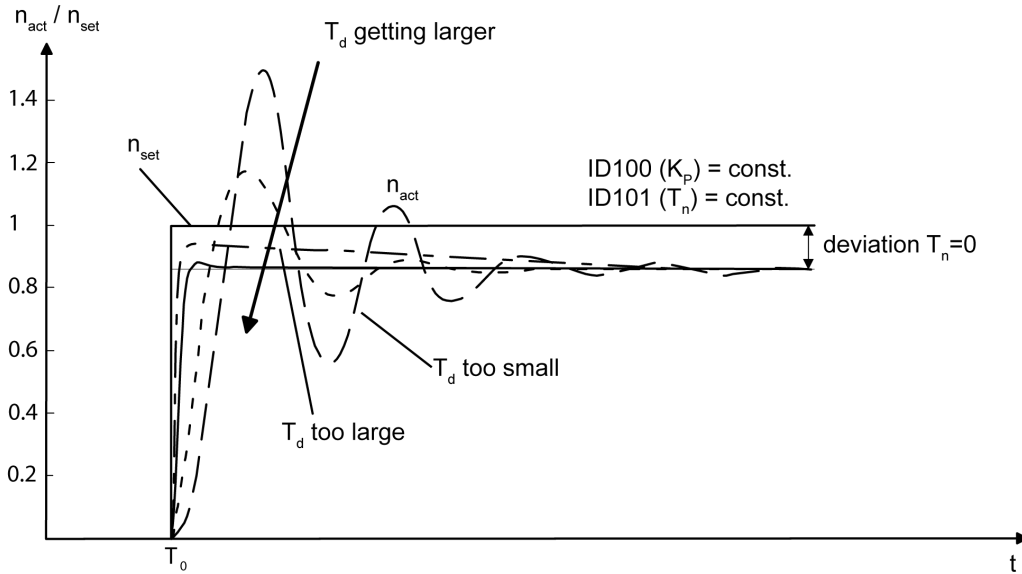

## 9.7.2 AIPEX PRO settings

### Configuring the oscilloscope

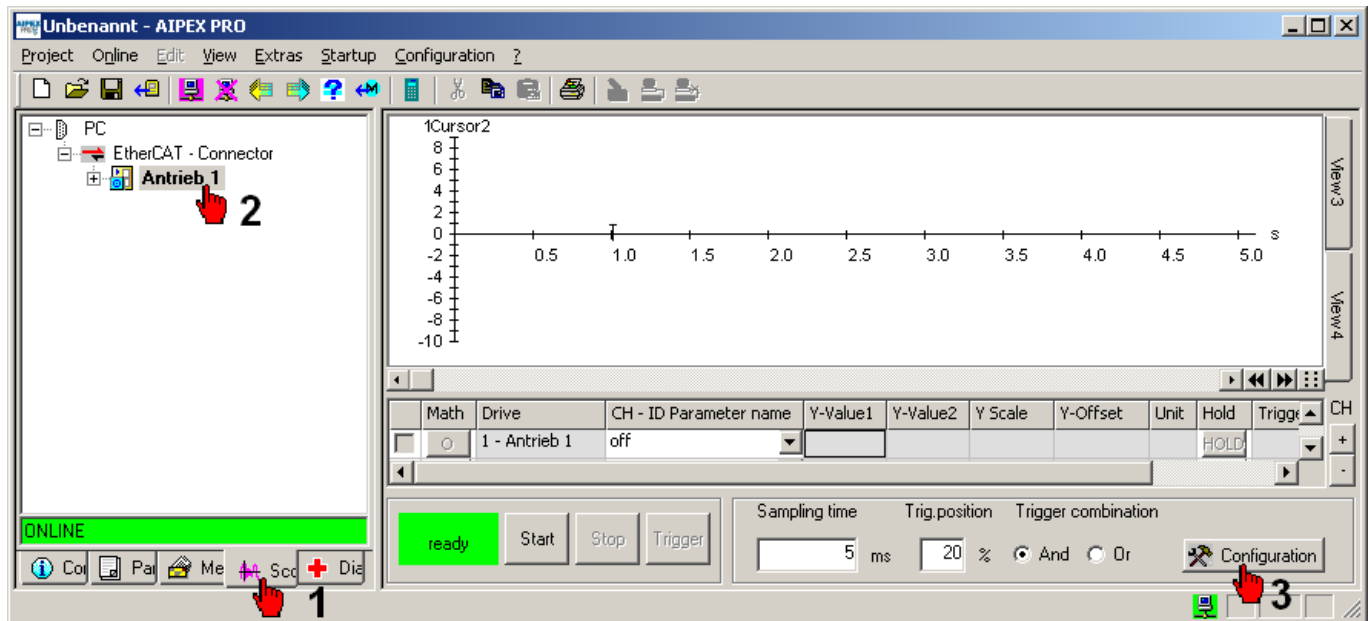

Open the 'Channels configuration' window (3).

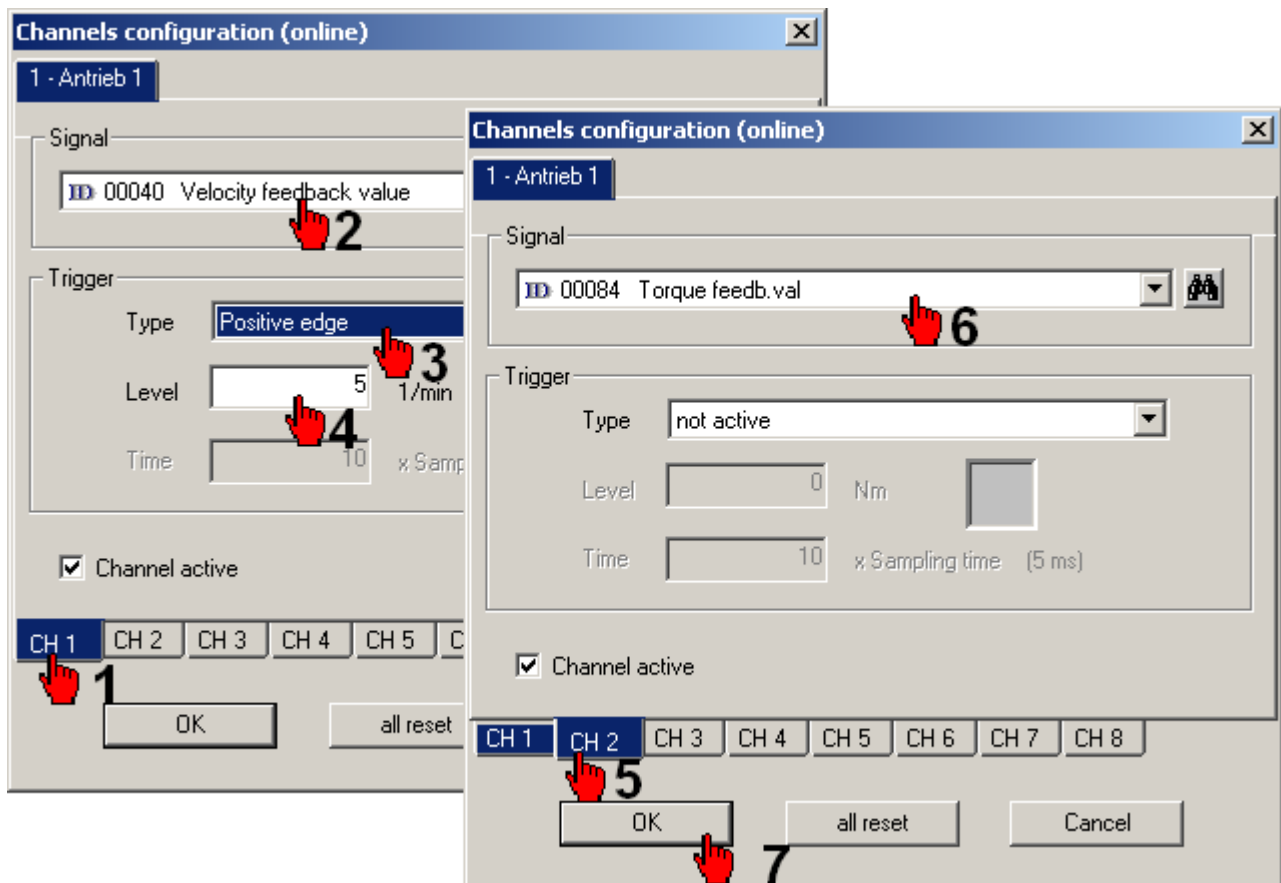
**CH1:**

- Signal: ID40 'Velocity feedback value'
- Trigger:
  - Type: Positive edge
  - Level: 5 1/min (the recording is started when the actual speed value exceeds 5 rpm)

**CH2:**

- Signal: ID84 'Torque feedback value'
- Trigger: not active

**CH3:**

- Signal: ID34299 'Velocity setpoint in control'
- Trigger: not active

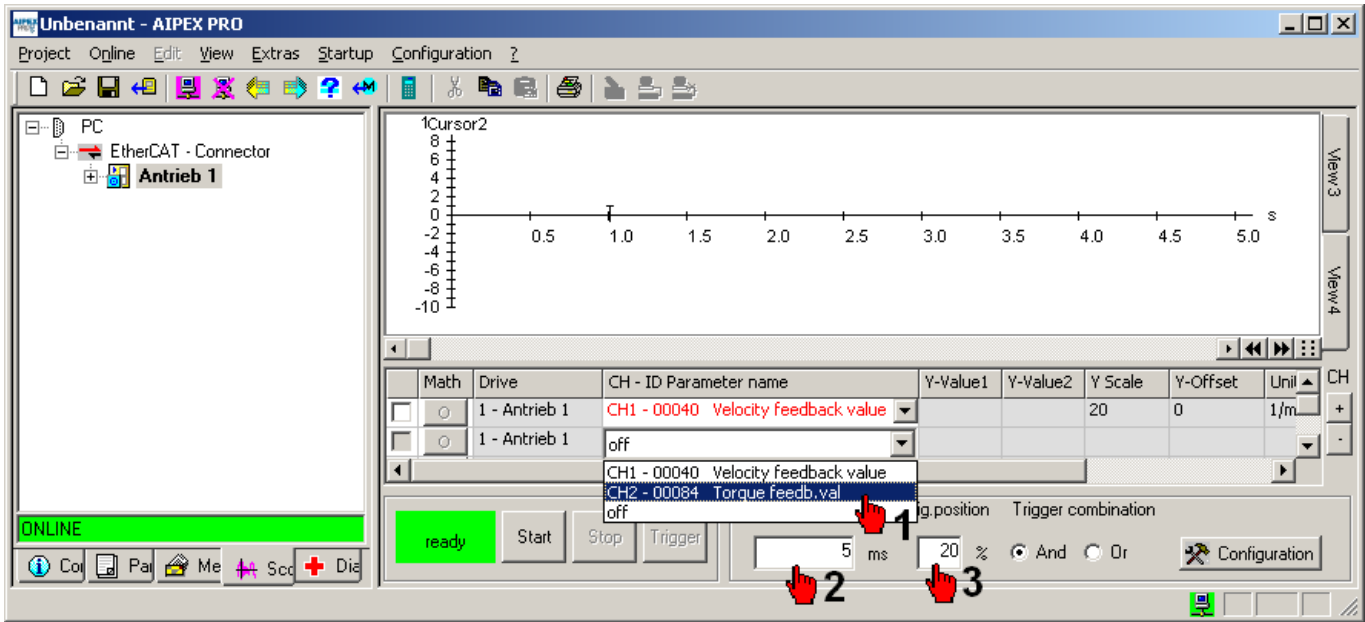

Activate the configured signals by the pull-down menu 'CH - ID Parameter name'



**Maximum recording time**

The maximum recording time is affected by the variable data memory size, as well as the configured measuring signals and the sampling time

The data memory in the drive can be configured with ID34284 'OSC container length'.

The default value is 4096 bytes, the maximum value is 32600 bytes.

See: AIPEX PRO documentation

Topic: Scope - Maximum recording time

**Configure 'Temporary parameters...'**

Open the 'Temporary parameters...' window in the 'Startup' menu.

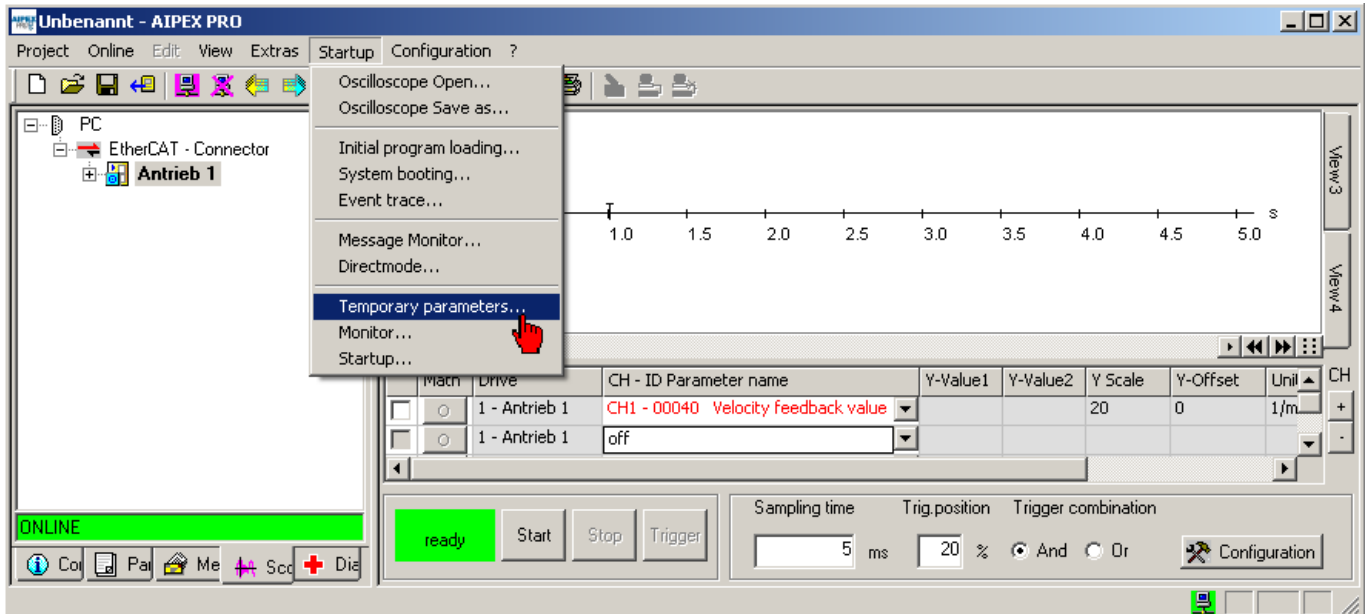

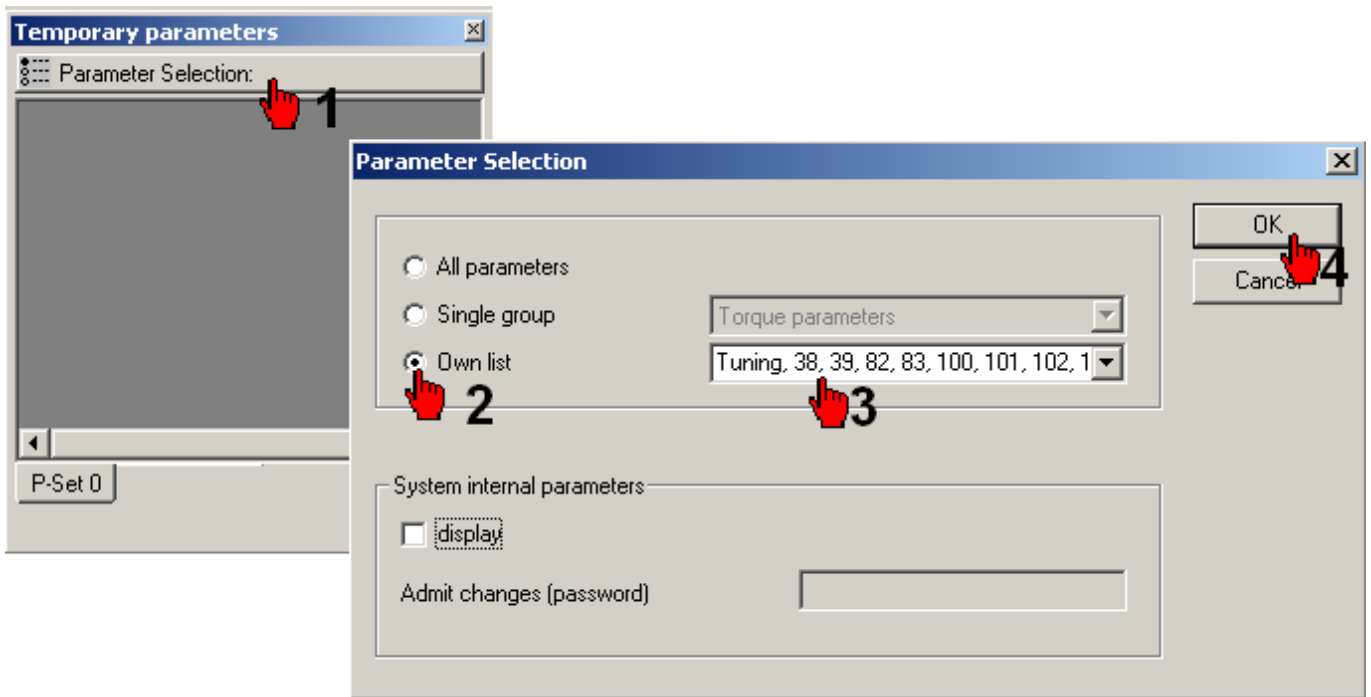

Configure your 'Own list' by entering a name and the parameter IDs which are relevant for the controller settings. We recommend the following input:  
 >own list name<,>38,39,82,83,100,101,102

Display own list 'Tuning':

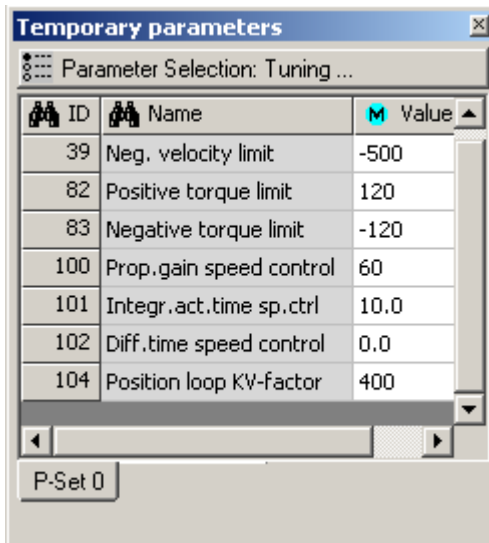

**Configure 'Startup function' (Test generator)**

**Preparation (test generator without CAN control)**

The inverter needs the signal RF controller enable to energize the motor. RF can be set for testing via a hardware switch. For this, the following parameters must be adapted. Additionally deactivate the special functionality FSE, so that you can use the 'Test generator'.

**Hardware**

Wire the required RF controller enable signal via a hardware switch to terminal X140 on the controller card.  
 X140 connection 3B: 24 VDC  
 X140 connection 1B: 0 VDC Reference potential

**Parameterization**

'Binary inputs assignment' is used to set the code RF controller enable to assigned to the binary input ID32978 'Port 3 Bit 0'  
 Input value: 32904 (meaning: Code RF inverter enable)

The 'System parameters' group is used to set the controller enable RF source hardware.  
 ID32796 'Source RF'  
 Input value: 0 dec (meaning: RF via digital input)

The 'System parameters' group is used to deactivate the FSE special function.  
 ID32901 'Global service bits'  
 Input value: 0x240 (meaning: FSE special function deactivate)



After commissioning, the parameters must be reset to the FSE value and the drive restarted.

Open 'Startup...' (Test generator...) in the 'Startup' menu (PW: 500591).

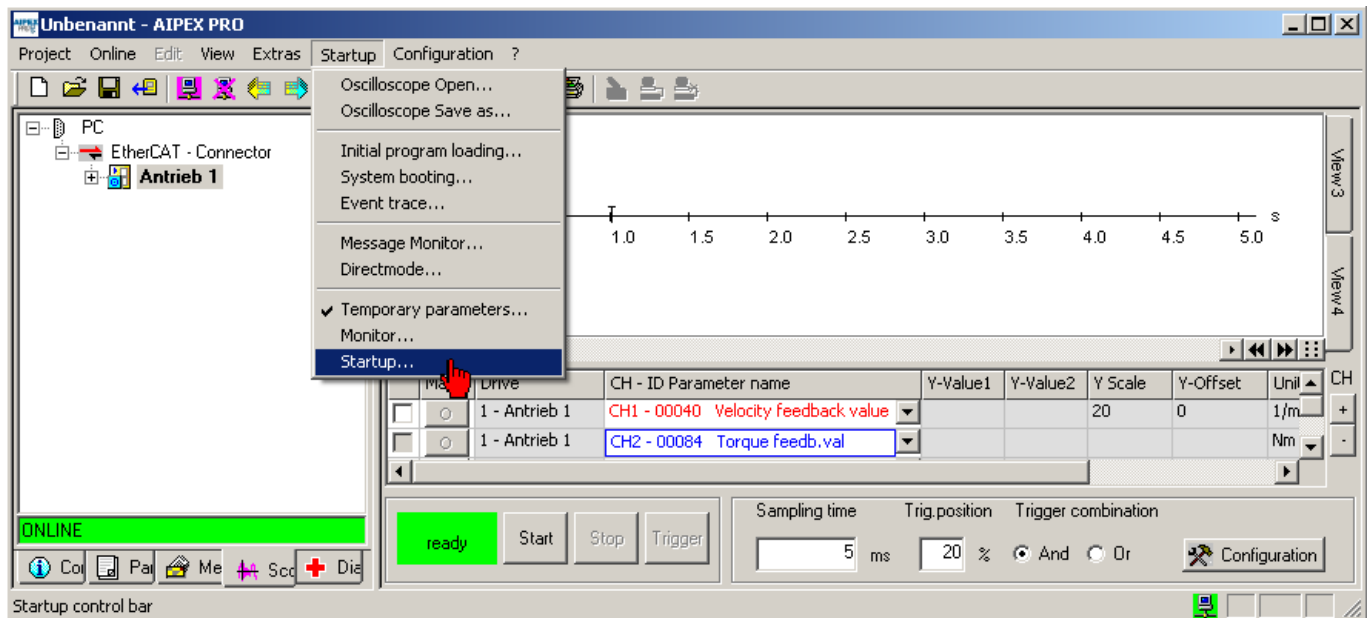

Select 'Rectangle setpoint' as speed setpoint step-change.



The following measured actual torque value has always to be less than the set torque limits.  
 If the torque limits are exceeded, the value of 'Amplitude High (Ah)' must be reduced.  
 Recommended start value: 100 1/min

### 9.7.3 Optimising the speed controller

Repeat the steps to optimize the speed controller until the controller behaviour meets your idea of dynamic and rigidity.

In the 'Temporary parameters' window, you can enter the parameter values before you take a new measurement. The input is directly valid.

ID	Name	Value	Unit
38	Pos. velocity limit	100	1/min
39	Neg. velocity limit	-100	1/min
82	Positive torque limit	10	% MN
83	Negative torque limit	-10	% MN
100	Prop.gain speed control	60	
101	Integr.act.time sp.ctrl	10.0	ms
102	Diff.time speed control	0.0	ms
104	Position loop KV-factor	400	

After the measurement has finished, the results are transferred to the PC and displayed automatically.

Interpret the measurement.

By means of 'Temporary parameters', you can optimise the P part (ID100), I part (ID101), and D part (ID102).

The button 'HOLD' saves the selected value so that you can compare it to the next measurement.

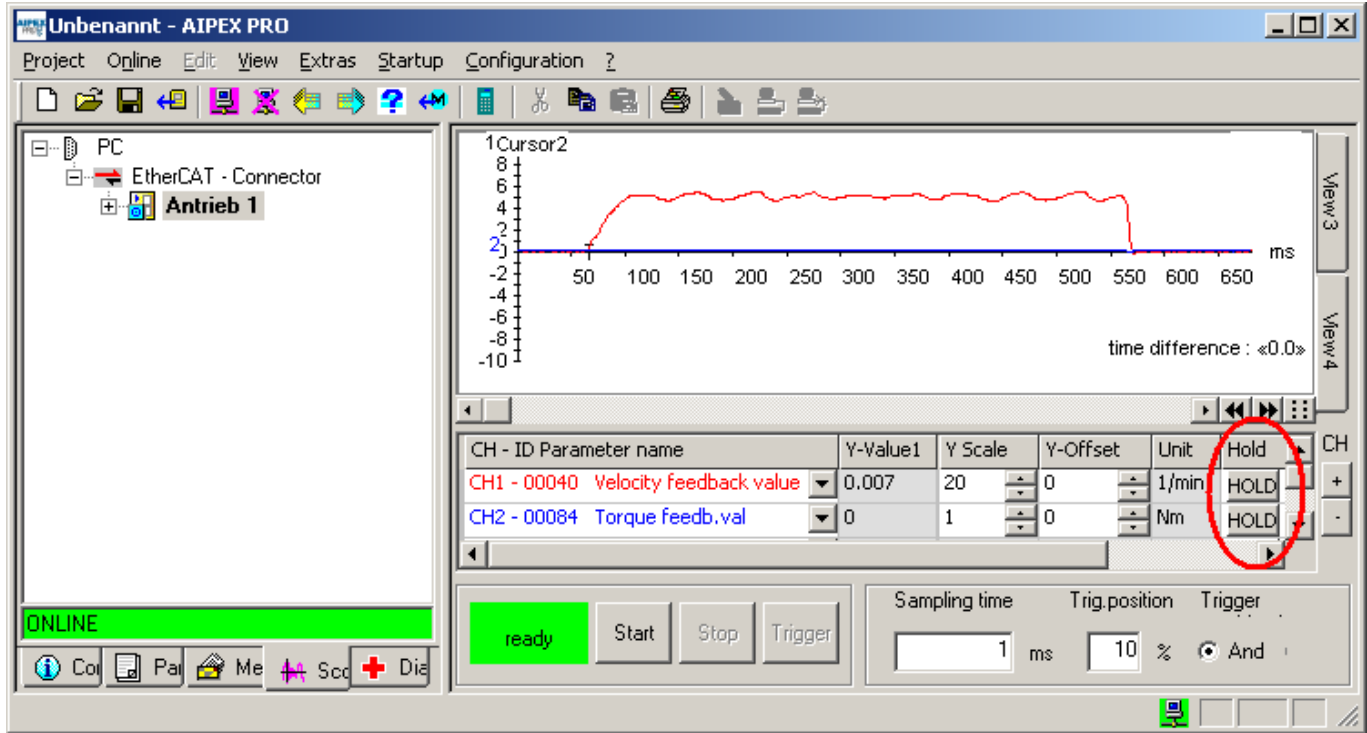



## 10 Service

### 10.1 Error diagnosis with AIPEX PRO

With 'Diagnostics', the diagnostic messages can be read out from the selected device.

Click on each message to receive an explanation for it. You get further information if you analyse Info (I), I2 and I3

The first message of the list is the main activator of the fault; further displayed numbers might be resulting errors which will not appear any longer after rectifying the cause of the first diagnostic message.

#### Button '**New reading**'

Diagnostic messages will be read out from the selected device.

#### Button '**Error reset**'

The errors will be deleted in the selected device .

#### Button '**Error reset - via BUS**'

The errors of all devices of a bus line will be deleted. To do this, select the bus in the device tree.

After the causing error is rectified successfully, 'Error reset' activates a system restart and the system ready message SBM is set.

Diagnosis with AIPEX PRO (tab 'Diagnostics')

The screenshot shows the AIPEX PRO software interface. On the left is a tree view of the system components, including 'EtherCAT - Connector', 'Antrieb 1', 'KW 2', 'Motor', 'KW-R06', 'ACC - Connector X137', and 'Supply 33'. The main window displays a table of error codes:

Number	Text	Class (K)	Modul (...)	Code (F)	Info (I)	2	13	14 (Adr)
1	2311 Encoder signal	4	5	7	1	0	0	0

Below the table are buttons for 'New reading', 'Error reset', and 'Error reset - via BUS'. The main diagnostic area is titled '2311 Encoder signal' and contains the following information:

- Motor encoder defective
- Encoder cable defective or not connected
- Motor is equipped with a D encoder
- Possibly A encoder with defective field plates
- The SINE encoder monitoring can be switched off through ID32773

Additional error information is provided in a table:

Info	Code	Description
Info 1	1	AI/T encoder hardware: Inadmissible level at the encoder input
	2	AI/T encoder amplitude: The amplitude at the A/D converter input of an encoder track is less than 0.6 V

The 'ONLINE' status bar at the bottom left is highlighted in green. A red circle highlights the 'Info (I)' column in the error table, and another red circle highlights the 'Additional Error Information (AMK Service)' table.

Diagnosis in direct mode

**2311 Encoder signal**

- Motor encoder defective
- Encoder cable defective or not connected
- Motor is equipped with a D encoder
- Possibly A encoder with defective field plates
- The SINE encoder monitoring can be switched off through ID32773

Device	Description	Class	Drive Behaviour	Device Behaviour	Additional Error Information (AMK Service)									
			Drive runs down	Single treatment	<table border="1"> <thead> <tr> <th>Info</th> <th>Value</th> <th>Description</th> </tr> </thead> <tbody> <tr> <td>info 1</td> <td>1</td> <td>A/D encoder hardware: Inadmissible level at the encoder input</td> </tr> <tr> <td></td> <td>2</td> <td>A/D encoder amplitude. The amplitude at the A/D converter input of an encoder track is less than 0.6 V (normal level: 2 V). Filtration: 5x within 50 ms leads to shutdown.</td> </tr> </tbody> </table>	Info	Value	Description	info 1	1	A/D encoder hardware: Inadmissible level at the encoder input		2	A/D encoder amplitude. The amplitude at the A/D converter input of an encoder track is less than 0.6 V (normal level: 2 V). Filtration: 5x within 50 ms leads to shutdown.
Info	Value	Description												
info 1	1	A/D encoder hardware: Inadmissible level at the encoder input												
	2	A/D encoder amplitude. The amplitude at the A/D converter input of an encoder track is less than 0.6 V (normal level: 2 V). Filtration: 5x within 50 ms leads to shutdown.												

10.2 Firmware 'FSER25\_SW\_102\_1951\_207666' flash



The ZIP file 'FSER25\_SW\_102\_1951\_207666.zip' contains the software version 'KW 211 1951 207666'.

NOTICE	
	<p><b>Firmware Download</b></p> <p>Due to download a firmware, application-specific parameter settings are overwritten and become invalid!</p> <p><b>Steps to prevent:</b></p> <ul style="list-style-type: none"> <li>• BEFORE you download a new firmware, please make really sure that application-specific data is saved as backup.</li> </ul>

**NOTICE**

**Material Damage!**

**Damage to the hardware**

Connecting or disconnecting the interface connectors while they are carrying voltage can damage the hardware.

**Steps to prevent:**

- Only connect or disconnect the interface connectors when the device is switched off.

**Step 1: Create connection between PC and inverter via EtherCAT (connection X85)**

Example: Inverter 'W1'

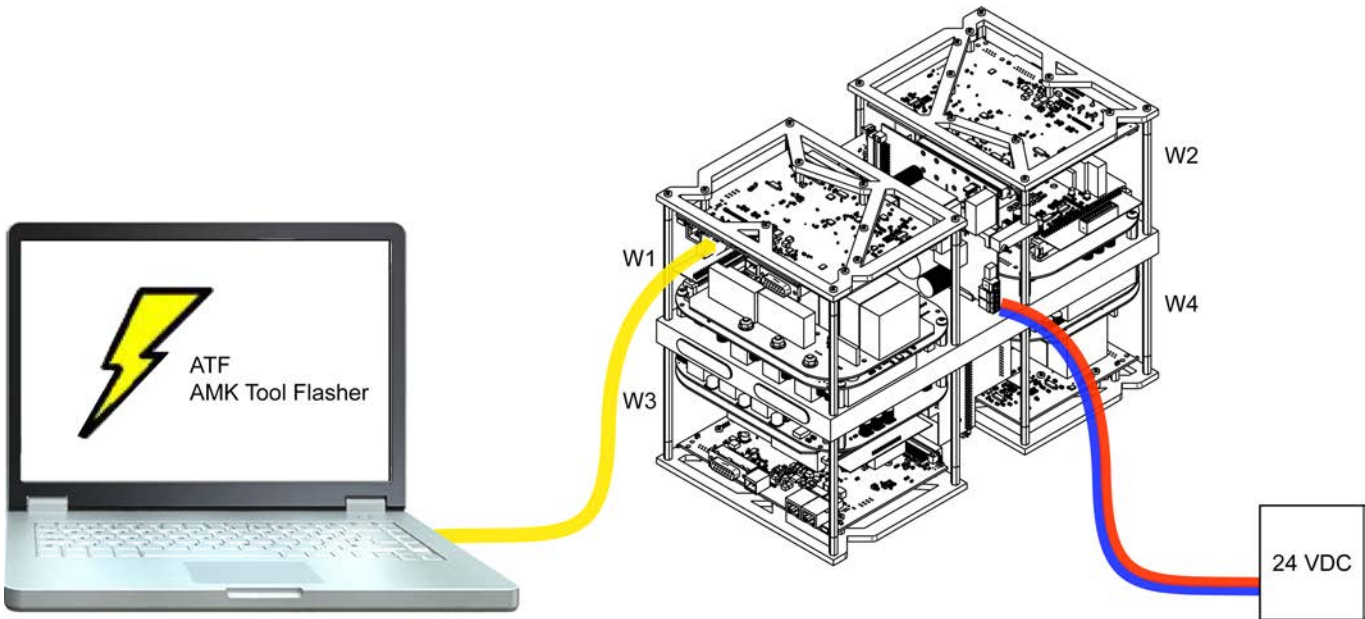

**Step 2: 24 VDC logic supply 'on'**

Wait for device initialization. The initialization is finished if the following led is on.

	LED	green	orange	red
Controller card -R25	H2	on	on	on

**Step 3: Execute software 'AIPEX PRO'**



Call AIPEX PRO menu 'Online' → 'Log on'

### Step 4: Read out firmware version

The current firmware version can be read from the ID30 'Software version' with AIPEX PRO.

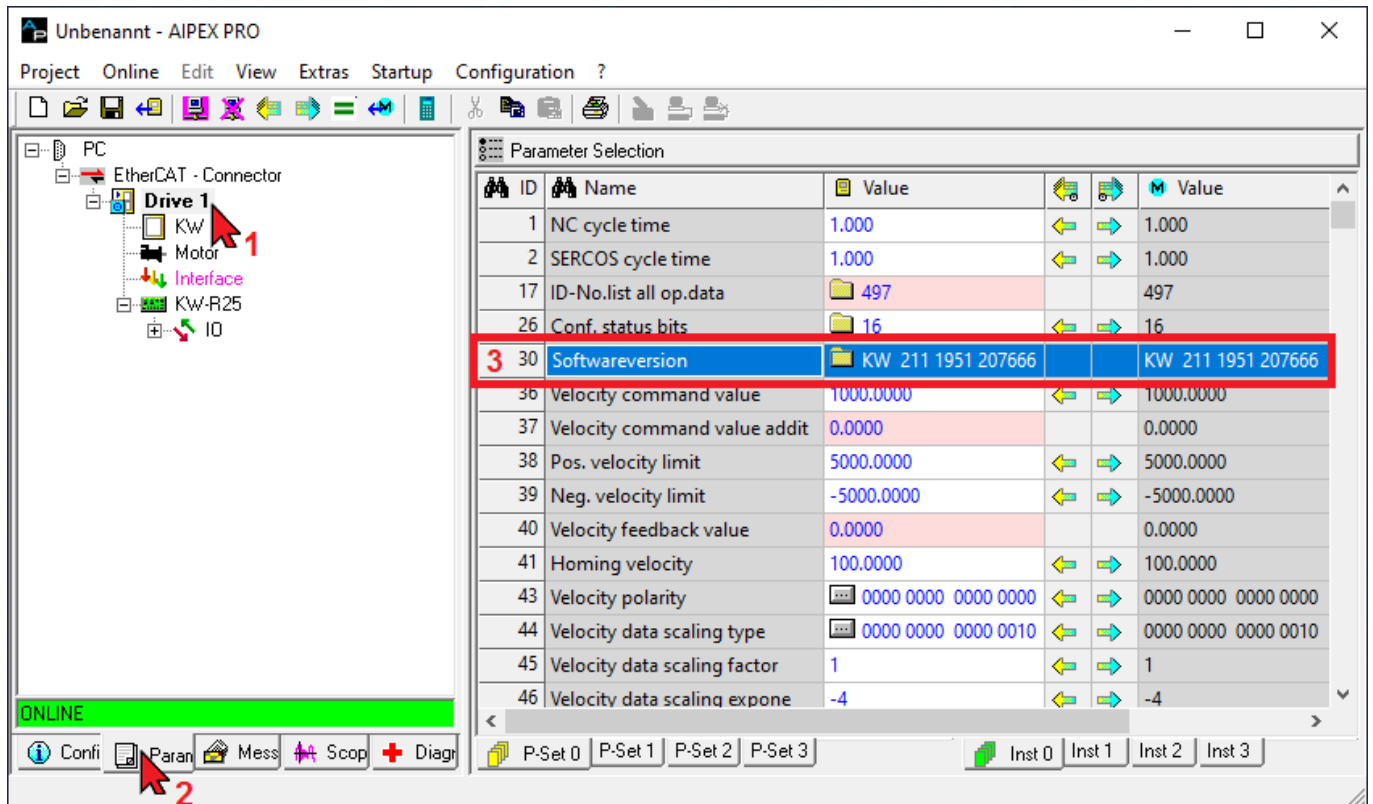

1. Select drive
2. Open tab 'Parameter'
3. Read 'ID30 'Software version'. **Current software version** → 'KW 211 1951 207666'

If the software version read differs from the software version specified here (KW 211 1951 207666), the following steps must be carried out.

### Step 5: Execute software 'ATF'



AIPEX PRO V3 must be closed!

## Step 6: Add programming task

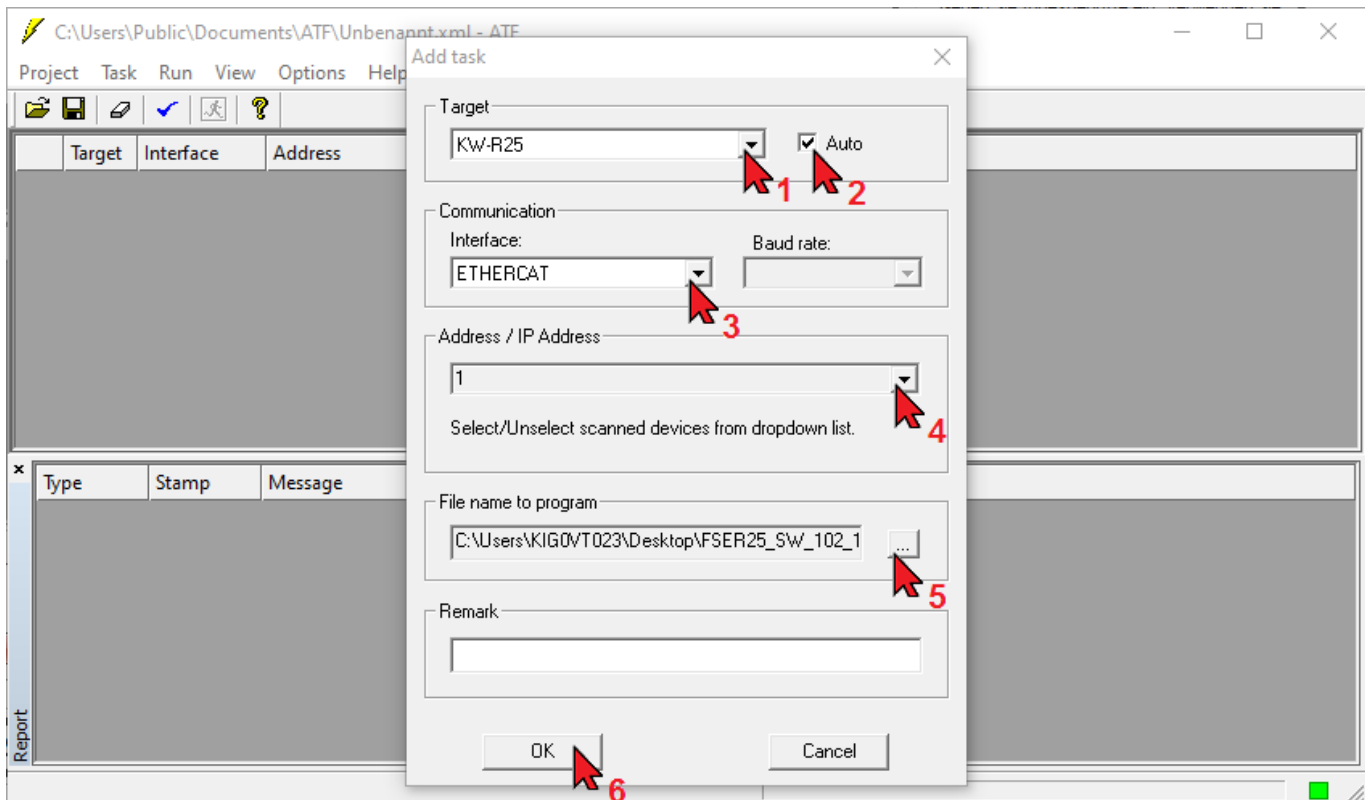
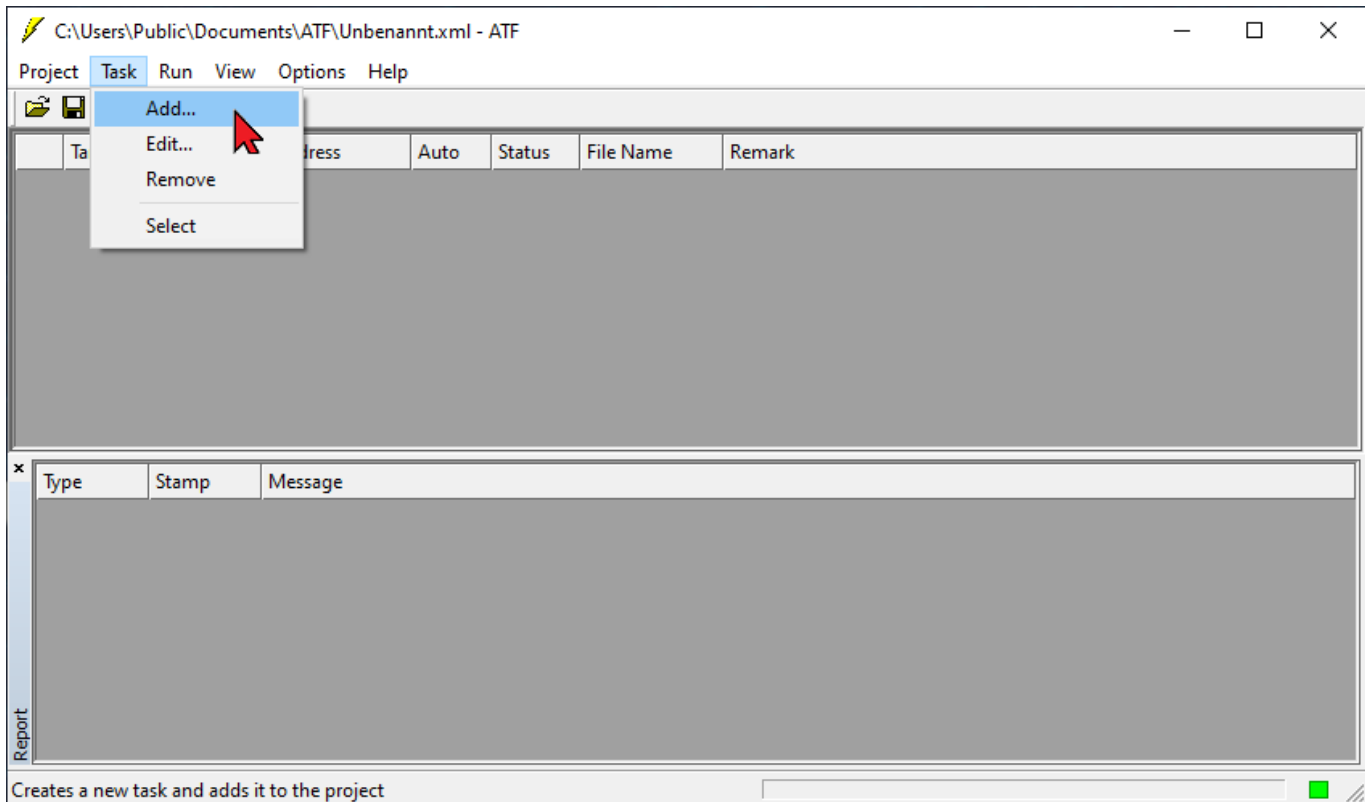

### Target

1. Select target hardware
2. Activate the option 'Auto': ATF activate the flash mode automatically.

If the option 'Auto' is deactivated, the user must activate the flash mode manually. E. g. the user have to set a jumper at the hardware to activate the flash mode.

**Communication**

3. Select 'Interface' (connection between PC and inverter).

**Address / IP Address**

4. Adjust bus participant address.

AMK factory setting address:

EtherCAT: 1



The bus participant address can be read and displayed with AIPEX PRO menu 'Direct mode' → 'Communication'

**File name to program**

5. Select firmware version (FSER25\_SW\_102\_1951\_207666)

6. Accept with 'OK'

**Step 7: Flashing the firmware**

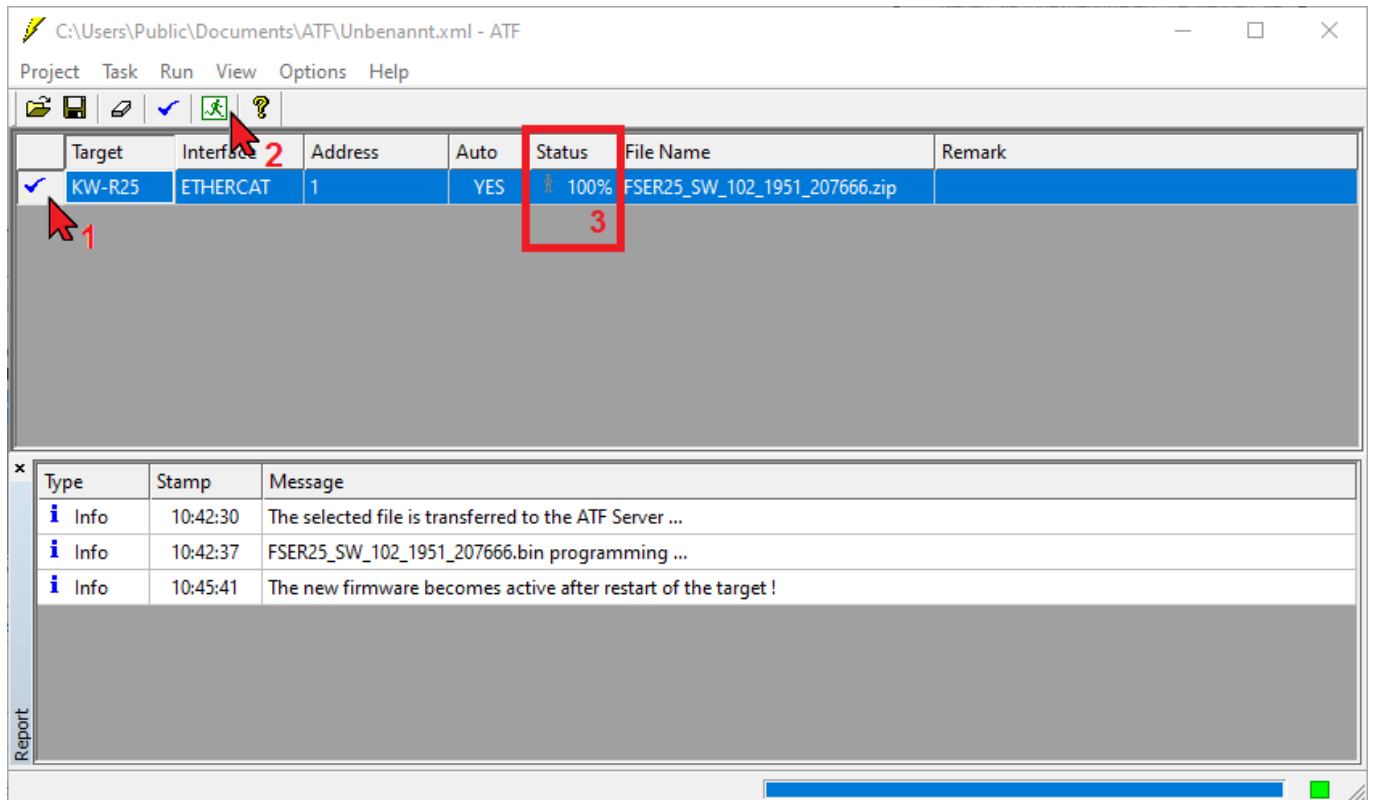

1. Select programming task.
2. Execute flashing.



The transfer and flashing of the firmware may take several minutes, depending on the connection!  
Do not, under any circumstances, switch off or disconnect the device!

3. Status 100%, switch off the device, wait at least 10 s, and then switch the device back on.

**Step 8: Close software 'ATF'**

**Step 9: 24 VDC logic supply 'on'**

Wait for device initialization. The initialization is finished if the following led is on.

	LED	green	orange	red
Controller card -R25	H2	on	on	on

## Step 10: Execute software 'AIPEX PRO'



Call AIPEX PRO menu 'Online' → 'Log on'



If the new firmware is not address compatible with the parameter memory data, the device generate automatically the request for 'Initial Loading' (error message '1293'). Accept with 'OK'

After initial loading you have to do a power cycle (24 VDC off/on), following you have to reload the customer specific parameters (manually or with AIPEX PRO).

## Step 11: Read out firmware version

The current firmware version can be read from the ID30 'Software version' with AIPEX PRO.

The screenshot shows the AIPEX PRO software interface. On the left, a tree view shows the project structure with 'Drive 1' selected. The main window displays a 'Parameter Selection' table. The table has columns for ID, Name, Value, and a second Value column. The row for ID 30, 'Softwareversion', is highlighted in red, with its value 'KW 211 1951 207666' also highlighted. A red arrow points to the 'Paran' button in the bottom toolbar.

ID	Name	Value	Value
1	NC cycle time	1.000	1.000
2	SERCOS cycle time	1.000	1.000
17	ID-No.list all op.data	497	497
26	Conf. status bits	16	16
30	Softwareversion	KW 211 1951 207666	KW 211 1951 207666
36	Velocity command value	1000.0000	1000.0000
37	Velocity command value addit	0.0000	0.0000
38	Pos. velocity limit	5000.0000	5000.0000
39	Neg. velocity limit	-5000.0000	-5000.0000
40	Velocity feedback value	0.0000	0.0000
41	Homing velocity	100.0000	100.0000
43	Velocity polarity	0000 0000 0000 0000	0000 0000 0000 0000
44	Velocity data scaling type	0000 0000 0000 0010	0000 0000 0000 0010
45	Velocity data scaling factor	1	1
46	Velocity data scaling expone	-4	-4

1. Select drive
2. Open tab 'Parameter'
3. Read 'ID30 'Software version''. **Current software version** → 'KW 211 1951 207666'

→ Repeat steps 1 - 11 for the inverters W2, W3 and W4!



## 11 Certificates

The certificates are available through AMKmotion sales or on the AMKmotion website.

- Declaration of conformity

You can get it as follows:

- AMKmotion homepage - service - download - registration - start online documentation - certificates  
(One-time manual activation by AMKmotion sales department is necessary.  
The auto-registration via AMKmotion homepage does not include access to the entire documentation.)

[www.amk-motion.com/en/content/download\\_area](http://www.amk-motion.com/en/content/download_area)



## Glossary

### A

#### AIPEX

AMK startup and parameterizing software (PC software): Programming, parameterization, configuration, diagnosis, oscilloscope, status information

#### ATF

AMK Tool Flasher (PC software for transferring firmware to device)

#### AWG

American Wire Gauge (Coding of wire diameter)

### B

#### BA

Binary output

#### BE

Digital input

### C

#### CAN

Controller Area Network

#### COB-ID

Communication Object Identifier (Address of a telegram in CANopen protocol)

### D

#### Default

Factory setting

### E

#### ESD

Electrostatic discharge

#### EnDat 2.2

Motor encoder interface protocol of the company Heidenhain

#### EnDat 2.1

Motor encoder interface protocol of the company Heidenhain

#### EMC

Electromagnetic compatibility

#### EF

Power output stage enable

#### EGB

Electrostatic endangered component

#### EF2

Power output stage enable

#### EtherCAT

Real-time Ethernet bus

#### EMV

Electromagnetic compatibility

### F

#### Firmware

System software, loaded by AMK

### G

#### GND

Ground potential

### H

#### HV

High voltage; DC bus

### I

#### I/O

Input / output

#### $i^2t$

Integral of the squared current over time

#### ID

Parameter identification numbers acc. to SERCOS Standard

#### IGBT

Power electronic component, e. g. transistor

### K

#### KP

Proportional gain (speed control, PID controller)

#### KW

AMKASYN compact inverter

#### KW-Rxx

AMKASYN controller card for installation into compact inverter

#### KTY

Type of a temperature sensor

### M

#### MCE

Motor Controller Electronic

**P****Parameter**

Identification number acc. to SERCOS standard

**PDK\_#####\_abcdefgh**

Product documentation; ##### - AMK part no. , abcdefgh - name

**Q****QRF**

Acknowledgment controller enable; the drive is controlled in the activated operation mode

**R****RF**

Command 'Controller enable'; the drive is energized and will be controlled depending on the selected operation mode. Controller enable can only be set if the device is error-free (SBM = TRUE) and acknowledgement DC bus on is set (QUE = TRUE). Acknowledgment controller enable (QRF) is set.

**S****SBM**

System ready message; shows that the device is error-free In case of error. SBM will be reset

**SoE**

Servodrive Profile (SERCOS) over EtherCAT (Acc. to IEC 61800-7-300)

**T****Td**

Differentiating time in speed control (PID controller)

**Tn**

Integral-action time in speed control (PID controller)

**W****WEF**

Reference potential power output stage enable

## Your opinion is important!

With our documentation we want to offer you the highest quality support in handling the AMKmotion products.

That is why we are now working on optimizing our documentation.

Your comments or suggestions are always of interest to us.

We would be grateful if you take a bit of time and answer our questions. Please return a copy of this page to us.



e-mail: [Documentation@amk-motion.com](mailto:Documentation@amk-motion.com)

or

fax no.: +49 7021/50 05-199

**Thank you for your assistance.**

**Your AMKmotion documentation team**

1. How would you rate the layout of our AMKmotion documentation?  
(1) very good (2) good (3) satisfactory (4) less than satisfactory (5) poor
2. Is the content structured well?  
(1) very good (2) good (3) moderate (4) hardly (5) not at all
3. How easy is it to understand the documentation?  
(1) very easy (2) easy (3) moderately easy (4) difficult (5) extremely difficult
4. Did you miss any topics in the documentation?  
(1) no (2) if yes, which ones:
5. How would you rate the overall service at AMKmotion?  
(1) very good (2) good (3) satisfactory (4) less than satisfactory (5) poor

AMKmotion GmbH + Co KG

Phone : +49 7021/50 05-0, fax: +49 7021/50 05-199

E-Mail: [info@amk-motion.com](mailto:info@amk-motion.com)

Homepage: [www.amk-motion.com](http://www.amk-motion.com)